

BITSAT : SOLVED PAPER 2017

INSTRUCTIONS

- This question paper contains total 150 questions divided into four parts:
Part I : Physics Q. No. 1 to 40
Part II : Chemistry Q. No. 41 to 80
Part III : (A) English Proficiency Q. No. 81 to 90
(B) Logical Reasoning Q. No. 91 to 105
Part IV : Mathematics Q. No. 106 to 150
- All questions are multiple choice questions with four options, only one of them is correct.
- Each correct answer awarded 3 marks and -1 for each incorrect answer.
- Duration of paper-3 Hours

PART - I : PHYSICS

- What is the minimum energy required to launch a satellite of mass m from the surface of a planet of mass M and radius R in a circular orbit at an altitude of $2R$?
(a) $\frac{5GmM}{6R}$ (b) $\frac{2GmM}{3R}$ (c) $\frac{GmM}{2R}$ (d) $\frac{GmM}{2R}$
- A mercury drop of radius 1 cm is sprayed into 10^6 drops of equal size. The energy expressed in joule is (surface tension of Mercury is $460 \times 10^{-3} \text{ N/m}$)
(a) 0.057 (b) 5.7
(c) 5.7×10^{-4} (d) 5.7×10^{-6}
- Two plano-concave lenses (1 and 2) of glass of refractive index 1.5 have radii of curvature 25 cm and 20 cm. They are placed in contact with their curved surface towards each other and the space between them is filled with liquid of refractive index $4/3$. Then the combination is

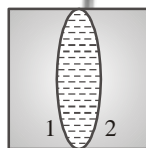

- convex lens of focal length 70 cm
 - concave lens of focal length 70 cm
 - concave lens of focal length 66.6 cm
 - convex lens of focal length 66.6 cm
- A charged particle moves through a magnetic field perpendicular to its direction. Then
(a) kinetic energy changes but the momentum is constant
(b) the momentum changes but the kinetic energy is constant

- both momentum and kinetic energy of the particle are not constant
 - both momentum and kinetic energy of the particle are constant
- After two hours, one-sixteenth of the starting amount of a certain radioactive isotope remained undecayed. The half life of the isotope is
(a) 15 minutes (b) 30 minutes
(c) 45 minutes (d) 4 hour
 - A coil of inductance 300 mH and resistance 2Ω is connected to a source of voltage 2 V. The current reaches half of its steady state value in
(a) 0.1 s (b) 0.05 s
(c) 0.3 s (d) 0.15 s
 - Two concentric conducting thin spherical shells A, and B having radii r_A and r_B ($r_B > r_A$) are charged to Q_A and $-Q_B$ ($|Q_B| > |Q_A|$). The electric field along a line passing through the centre is

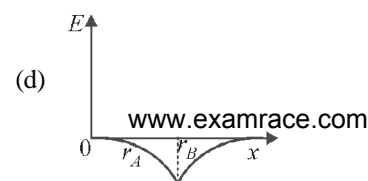
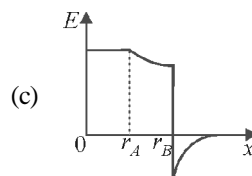
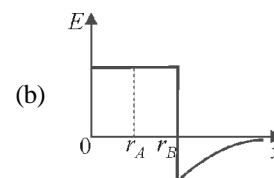
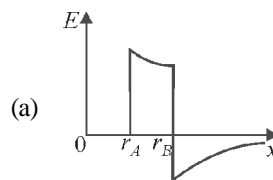

8. A capillary tube of radius R is immersed in water and water rises in it to a height H . Mass of water in the capillary tube is M . If the radius of the tube is doubled, mass of water that will rise in the capillary tube will now be :
- (a) M (b) $2M$
(c) $M/2$ (d) $4M$
9. A sonometer wire resonates with a given tuning fork forming standing waves with five antinodes between the two bridges when a mass of 9 kg is suspended from the wire. When this mass is replaced by a mass M , the wire resonates with the same tuning fork forming three antinodes for the same positions of the bridges. The value of M is
- (a) 25 kg (b) 5 kg
(c) 12.5 kg (d) $1/25\text{ kg}$
10. When a metal surface is illuminated by light of wavelengths 400 nm and 250 nm , the maximum velocities of the photoelectrons ejected are v and $2v$ respectively. The work function of the metal is (h - Planck's constant, c = velocity of light in air)
- (a) $2hc \times 10^6\text{ J}$ (b) $1.5hc \times 10^6\text{ J}$
(c) $hc \times 10^6\text{ J}$ (d) $0.5hc \times 10^6\text{ J}$
11. Two conducting shells of radius a and b are connected by conducting wire as shown in figure. The capacity of system is :

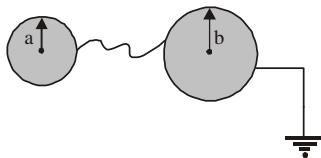

- (a) $4\pi\epsilon_0 \frac{ab}{b-a}$ (b) $4\pi\epsilon_0 (a+b)$
(c) zero (d) infinite
12. When ${}_{92}\text{U}^{235}$ undergoes fission, 0.1% of its original mass is changed into energy. How much energy is released if 1 kg of ${}_{92}\text{U}^{235}$ undergoes fission
- (a) $9 \times 10^{10}\text{ J}$ (b) $9 \times 10^{11}\text{ J}$
(c) $9 \times 10^{12}\text{ J}$ (d) $9 \times 10^{13}\text{ J}$
13. One mole of an ideal gas is taken from state A to state B by three different processes,

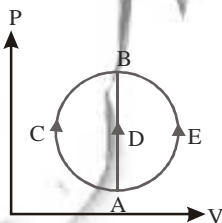

- (i) ACB (ii) ADB (iii) AEB as shown in the P-V diagram. The heat absorbed by the gas is
- (a) greater in process (ii) than in (i)
(b) the least in process (ii)
(c) the same in (i) and (iii)
(d) less in (iii) than in (ii)

14. In the formula $X = 3YZ^2$, X and Z have dimensions of capacitance and magnetic induction respectively. The dimensions of Y in MKSA system are :

- (a) $[M^{-3}L^{-2}T^{-2}A^{-4}]$ (b) $[ML^{-2}]$
(c) $[M^{-3}L^{-2}A^4T^8]$ (d) $[M^{-3}L^2A^4T^4]$

15. Two very long, straight, parallel wires carry steady currents I and $-I$ respectively. The distance between the wires is d . At a certain instant of time, a point charge q is at a point equidistant from the two wires, in the plane of the wires. Its instantaneous velocity v is perpendicular to this plane. The magnitude of the force due to the magnetic field acting on the charge at this instant is

- (a) $\frac{\mu_0 I q v}{2\pi d}$ (b) $\frac{\mu_0 I q v}{\pi d}$ (c) $\frac{2\mu_0 I q v}{\pi d}$ (d) 0

16. Two projectiles A and B thrown with speeds in the ratio $1 : \sqrt{2}$ acquired the same heights. If A is thrown at an angle of 45° with the horizontal, the angle of projection of B will be
- (a) 0° (b) 60°
(c) 30° (d) 45°

17. A meter bridge is set up as shown, to determine an unknown resistance 'X' using a standard 10 ohm resistor. The galvanometer shows null point when tapping-key is at 52 cm mark. The end-corrections are 1 cm and 2 cm respectively for the ends A and B. The determined value of 'X' is

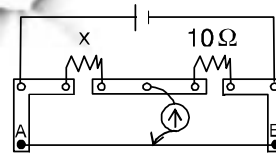

- (a) 10.2 ohm (b) 10.6 ohm
(c) 10.8 ohm (d) 11.1 ohm

18. A disk of radius $a/4$ having a uniformly distributed charge 6 C is placed in the x - y plane with its centre at $(-a/2, 0, 0)$. A rod of length a carrying a uniformly distributed charge 8 C is placed on the x -axis from $x = a/4$ to $x = 5a/4$. Two point charges -7 C and 3 C are placed at $(a/4, -a/4, 0)$ and $(-3a/4, 3a/4, 0)$, respectively. Consider a cubical surface formed by six surfaces $x = \pm a/2, y = \pm a/2, z = \pm a/2$. The electric flux through this cubical surface is

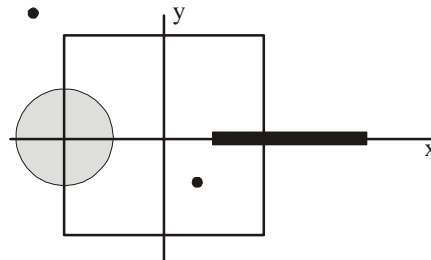

- (a) $\frac{-2C}{\epsilon_0}$ (b) $\frac{2C}{\epsilon_0}$
(c) $\frac{10C}{\epsilon_0}$ (d) $\frac{12C}{\epsilon_0}$ www.examrace.com

19. A particle of mass m moving in the x direction with speed $2v$ is hit by another particle of mass $2m$ moving in the y direction with speed v . If the collision is perfectly inelastic, the percentage loss in the energy during the collision is close to

- (a) 56% (b) 62%
(c) 44% (d) 50%

20. A coil is suspended in a uniform magnetic field, with the plane of the coil parallel to the magnetic lines of force. When a current is passed through the coil it starts oscillating; It is very difficult to stop. But if an aluminium plate is placed near to the coil, it stops. This is due to :

- (a) development of air current when the plate is placed
(b) induction of electrical charge on the plate
(c) shielding of magnetic lines of force as aluminium is a paramagnetic material.
(d) electromagnetic induction in the aluminium plate giving rise to electromagnetic damping.

21. A steel wire of length ' L ' at 40°C is suspended from the ceiling and then a mass ' m ' is hung from its free end. The wire is cooled down from 40°C to 30°C to regain its original length ' L '. The coefficient of linear thermal expansion of the steel is $10^{-5}/^\circ\text{C}$, Young's modulus of steel is 10^{11} N/m^2 and radius of the wire is 1 mm. Assume that $L \gg$ diameter of the wire. Then the value of ' m ' in kg is nearly

- (a) 1 (b) 2 (c) 3 (d) 5

22. On a hypotenuse of a right prism ($30^\circ - 60^\circ - 90^\circ$) of refractive index 1.50, a drop of liquid is placed as shown in figure. Light is allowed to fall normally on the short face of the prism. In order that the ray of light may get totally reflected, the maximum value of refractive index is :

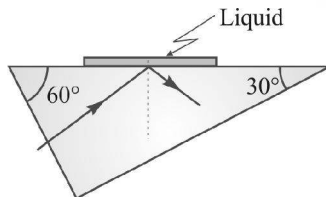

- (a) 1.30 (b) 1.47
(c) 1.20 (d) 1.25

23. A tuning fork of frequency 392 Hz, resonates with 50 cm length of a string under tension (T). If length of the string is decreased by 2%, keeping the tension constant, the number of beats heard when the string and the tuning fork made to vibrate simultaneously is :

- (a) 4 (b) 6
(c) 8 (d) 12

24. Hydrogen (H), deuterium (D), singly ionized helium (He^+) and doubly ionized lithium (Li^{++}) all have one electron around the nucleus. Consider $n = 2$ to $n = 1$ transition. The wavelengths of emitted radiations are $\lambda_1, \lambda_2, \lambda_3$ and λ_4 respectively. Then approximately :

- (a) $\lambda_1 = \lambda_2 = 4\lambda_3 = 9\lambda_4$
(b) $4\lambda_1 = 2\lambda_2 = 2\lambda_3 = \lambda_4$
(c) $\lambda_1 = 2\lambda_2 = 2\sqrt{2}\lambda_3 = 3\sqrt{2}\lambda_4$
(d) $\lambda_1 = \lambda_2 = 2\lambda_3 = 3\sqrt{2}\lambda_4$

25. The following figure depict a circular motion. The radius of the circle, the period of revolution, the initial position and the sense of revolution are indicated on the figure.

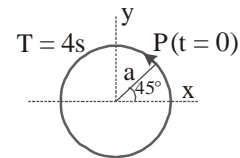

The simple harmonic motion of the x -projection of the radius vector of the rotating particle P can be shown as :

- (a) $x(t) = a \cos\left(\frac{2\pi}{4}t + \frac{\pi}{4}\right)$ (b) $x(t) = a \cos\left(\frac{\pi}{4}t + \frac{\pi}{4}\right)$
(c) $x(t) = a \sin\left(\frac{2\pi}{4}t + \frac{\pi}{4}\right)$ (d) $x(t) = a \cos\left(\frac{\pi}{3}t + \frac{\pi}{2}\right)$

26. There are two sources kept at distances 2λ . A large screen is perpendicular to line joining the sources. Number of maximas on the screen in this case is ($\lambda =$ wavelength of light)

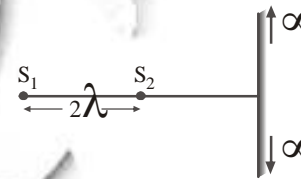

- (a) 1 (b) 3
(c) 5 (d) 7

27. In the circuit shown in figure the current through

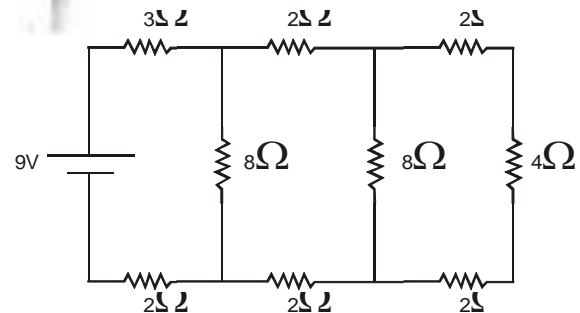

- (a) the $3\ \Omega$ resistor is 0.50 A.
(b) the $3\ \Omega$ resistor is 0.25 A.
(c) the $4\ \Omega$ resistor is 0.50 A
(d) the $4\ \Omega$ resistor is 0.25 A.

28. A telescope has an objective lens of 10 cm diameter and is situated at a distance of one kilometer from two objects. The minimum distance between these two objects, which can be resolved by the telescope, when the mean wavelength of light is $5000\ \text{\AA}$, is of the order of

- (a) 5 cm (b) 0.5 m (c) 5 m (d) 5 mm

29. During vapourisation

- I. change of state from liquid to vapour state occurs.
II. temperature remains constant.
III. both liquid and vapour states coexist in equilibrium.
IV. specific heat of substance increases.

Correct statements are

- (a) I, II and IV (b) II, III and IV
(c) I, III and IV (d) I, II and III

30. A wire is connected to a battery between the point M and N as shown in the figure (1). The same wire is bent in the form of a square and then connected to the battery between the points M and N as shown in the figure (2). Which of the following quantities increases ?

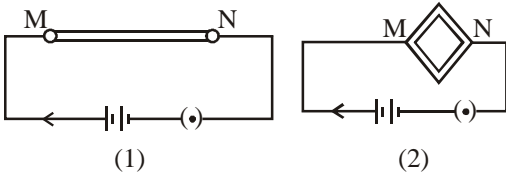

- (a) Heat produced in the wire and resistance offered by the wire.
(b) Resistance offered by the wire and current through the wire.
(c) Heat produced in the wire, resistance offered by the wire and current through the wire.
(d) Heat produced in the wire and current through the wire.
31. A body moves in a circular orbit of radius R under the action of a central force. Potential due to the central force is given by $V(r) = kr$ (k is a positive constant). Period of revolution of the body is proportional to :
- (a) $R^{1/2}$ (b) $R^{-1/2}$
(c) $R^{-3/2}$ (d) $R^{-5/2}$
32. Two equal heavy spheres, each of radius r , are in equilibrium within a smooth cup of radius $3r$. The ratio of reaction between the cup and one sphere and that between the two spheres is

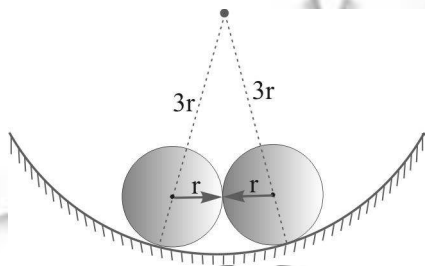

- (a) 1 (b) 2
(c) 3 (d) 4
33. A long, hollow conducting cylinder is kept coaxially inside another long, hollow conducting cylinder of larger radius. Both the cylinders are initially electrically neutral
- (a) A potential difference appears between the two cylinders when a charge density is given to the inner cylinder.
(b) A potential difference appears between two cylinders when a charge density is given to the outer cylinder.
(c) No potential difference appears between the two cylinders when a uniform line charge is kept along the axis of the cylinders.

- (d) No potential difference appears between the two cylinders when same charge density is given to both the cylinders.

34. A thin but rigid semicircular wire frame of radius r is hinged at O and can rotate in its own vertical plane. A smooth peg P starts from O and moves horizontally with constant speed v_0 , lifting the frame upward as shown in figure.

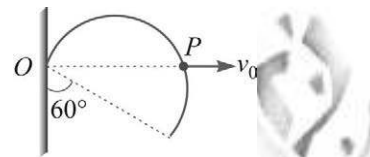

Find the angular velocity ω of the frame when its diameter makes an angle of 60° with the vertical :

- (a) v_0 / r (b) $v_0 / 2r$
(c) $2v_0 / r$ (d) $v_0 r$
35. Given that $A + B = R$ and $A = B = R$. What should be the angle between A and B ?
- (a) 0 (b) $\pi/3$ (c) $2\pi/3$ (d) π
36. The basic magnetization curve for a ferromagnetic material is shown in figure. Then, the value of relative permeability is highest for the point

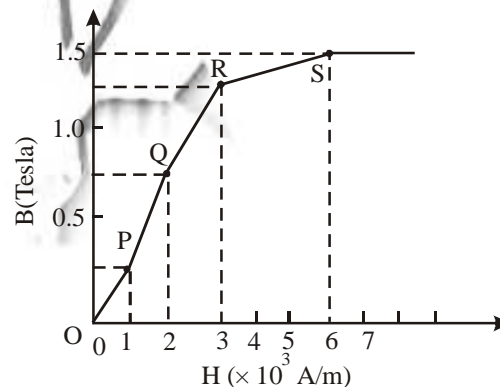

- (a) P (b) Q
(c) R (d) S
37. Five gas molecules chosen at random are found to have speeds of 500, 600, 700, 800 and 900 m/s:
- (a) The root mean square speed and the average speed are the same.
(b) The root mean square speed is 14 m/s higher than the average speed.
(c) The root mean square speed is 14 m/s lower than the average speed.
(d) The root mean square speed is $\sqrt{14}$ m/s higher than the average speed.

38. What is equivalent capacitance of circuit between points A and B?

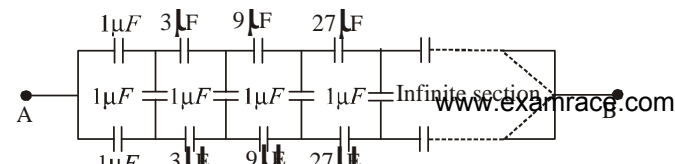

- (a) $\frac{2}{3} \mu t$ (b) $\frac{4}{3} \mu t$
 (c) Infinite (d) $(1 + \sqrt{3}) \mu t$

39. A cyclic process ABCD is shown in the figure P-V diagram. Which of the following curves represent the same process

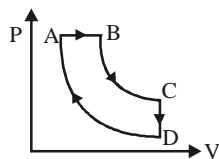

- (a) (b)
 (c) (d)

40. In the circuit given below, $V(t)$ is the sinusoidal voltage source, voltage drop $V_{AB}(t)$ across the resistance R is

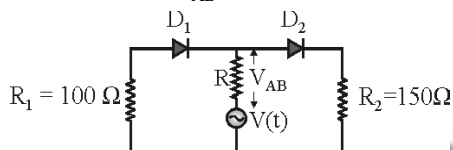

- (a) is half wave rectified
 (b) is full wave rectified
 (c) has the same peak value in the positive and negative half cycles
 (d) has different peak values during positive and negative half cycle

PART - II : CHEMISTRY

41. Which of the following can be repeatedly soften on heating?
 (i) Polystyrene (ii) Melamine
 (iii) Polyesters (iv) Polyethylene
 (v) Neoprene
 (a) (i) and (iii) (b) (i) and (iv)
 (c) (iii), (iv) and (v) (d) (ii) and (iv)
42. Which one of the following complexes is an outer orbital complex?
 (a) $[\text{Co}(\text{NH}_3)_6]^{3+}$ (b) $[\text{Mn}(\text{CN})_6]^{4-}$
 (c) $[\text{Fe}(\text{CN})_6]^{4-}$ (d) $[\text{Ni}(\text{NH}_3)_6]^{2+}$
43. For the reaction $\text{H}_2(\text{g}) + \text{Br}_2(\text{g}) \rightarrow 2\text{HBr}(\text{g})$, the experimental data suggest, $\text{rate} = k[\text{H}_2][\text{Br}_2]^{1/2}$. The molecularity and order of the reaction are respectively
 (a) $2, \frac{3}{2}$ (b) $\frac{3}{2}, \frac{3}{2}$
 (c) 1, 1 (d) $1, \frac{1}{2}$

44. Dead burn plaster is
 (a) $\text{CaSO}_4 \cdot 2\text{H}_2\text{O}$ (b) $\text{MgSO}_4 \cdot 7\text{H}_2\text{O}$
 (c) $\text{CaSO}_4 \cdot \frac{1}{2}\text{H}_2\text{O}$ (d) CaSO_4

45. Stronger is oxidising agent, more is
 (a) standard reduction potential of that species
 (b) the tendency to get it self oxidised
 (c) the tendency to lose electrons by that species
 (d) standard oxidation potential of that species
46. Which of the following relation represents correct relation between standard electrode potential and equilibrium constant?

- I. $\log K = \frac{nFE^\circ}{2.303 RT}$
 II. $K = e^{\frac{nFE}{RT}}$
 III. $\log K = \frac{-nFE^\circ}{2.303 RT}$
 IV. $\log K = 0.4342 \frac{nFE^\circ}{RT}$

Choose the correct statement(s).

- (a) I, II and III are correct
 (b) II and III are correct
 (c) I, II and IV are correct
 (d) I and IV are correct
47. Which of the following shows nitrogen with its increasing order of oxidation number?
 (a) $\text{NO} < \text{N}_2\text{O} < \text{NO}_2 < \text{NO}_3^- < \text{NH}_4^+$
 (b) $\text{NH}_4^+ < \text{N}_2\text{O} < \text{NO}_2 < \text{NO}_3^- < \text{NO}$
 (c) $\text{NH}_4^+ < \text{N}_2\text{O} < \text{NO} < \text{NO}_2 < \text{NO}_3^-$
 (d) $\text{NH}_4^+ < \text{NO} < \text{N}_2\text{O} < \text{NO}_2 < \text{NO}_3^-$
48. Raoult's law becomes a special case of Henry's law when
 (a) $K_H = p_1^\circ$ (b) $K_H > p_1^\circ$
 (c) $K_H < p_1^\circ$ (d) $K_H \geq p_1^\circ$

49. E° for the cell,

$\text{Zn} | \text{Zn}^{2+}(\text{aq}) || \text{Cu}^{2+}(\text{aq}) | \text{Cu}$ is 1.10 V at 25°C . The equilibrium constant for the cell reaction



is of the order of

- (a) 10^{-37} (b) 10^{37}
 (c) 10^{-17} (d) 10^{17}
50. Which of the following represents Gay Lussac's law ?

- I. $\frac{P}{T} = \text{constant}$ II. $P_1 T_2 = P_2 T_1$
 III. $P_1 V_1 = P_2 V_2$

Choose the correct option.

- (a) I, II and III (b) II and III
 (c) I and III (d) I and II

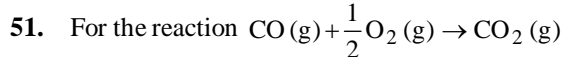

Which one of the statement is correct at constant T and P ?

- (a) $\Delta H = \Delta E$
 (b) $\Delta H < \Delta E$
 (c) $\Delta H > \Delta E$
 (d) ΔH is independent of physical state of the reactants

52. The energy of an electron in second Bohr orbit of hydrogen atom is :

- (a) $-5.44 \times 10^{-19} \text{ eV}$ (b) $-5.44 \times 10^{-19} \text{ cal}$
 (c) $-5.44 \times 10^{-19} \text{ kJ}$ (d) $-5.44 \times 10^{-19} \text{ J}$

53. Which of the following order is wrong?

- (a) $\text{NH}_3 < \text{PH}_3 < \text{AsH}_3$ — Acidic
 (b) $\text{Li} < \text{Be} < \text{B} < \text{C}$ — IE_1
 (c) $\text{Al}_2\text{O}_3 < \text{MgO} < \text{Na}_2\text{O} < \text{K}_2\text{O}$ — Basic
 (d) $\text{Li}^+ < \text{Na}^+ < \text{K}^+ < \text{Cs}^+$ — Ionic radius

54. Which of the following is not involved in the formation of photochemical smog?

- (a) Hydrocarbon (b) NO
 (c) SO_2 (d) O_3

55. Which of the following is not present in Portland cement?

- (a) Ca_2SiO_4 (b) Ca_3SiO_5
 (c) $\text{Ca}_3(\text{PO}_4)_2$ (d) $\text{Ca}_3\text{Al}_2\text{O}_6$

56. Which of the following can form buffer solution?

- (a) $\text{aq. NH}_3 + \text{NH}_4\text{OH}$ (b) $\text{KOH} + \text{HNO}_3$
 (c) $\text{NaOH} + \text{HCl}$ (d) $\text{KI} + \text{KOH}$

57. Which of the following complex shows sp^3d^2 hybridization?

- (a) $[\text{Cr}(\text{NO}_2)_6]^{3-}$ (b) $[\text{Fe}(\text{CN})_6]^{4-}$
 (c) $[\text{CoF}_6]^{3-}$ (d) $[\text{Ni}(\text{CO})_4]$

58. Which has glycosidic linkage?

- (a) amylopectin (b) amylase
 (c) cellulose (d) all of these

59. Which of the following represents Schotten-Baumann reaction?

- (a) formation of amides from amines and acid chlorides/
 NaOH
 (b) formation of amines from amides and LiAlH_4
 (c) formation of amines from amides and Br_2/NaOH
 (d) formation of amides from oxime and H_2SO_4

60. In the following structures, which two forms are staggered conformations of ethane ?

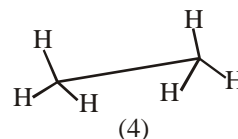
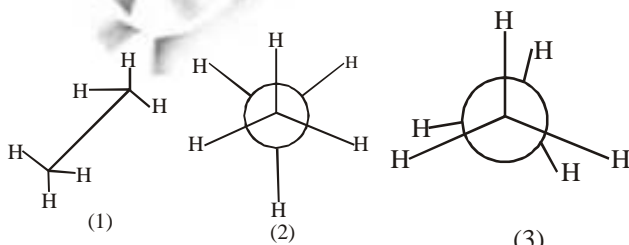

- (a) 1 and 4 (b) 2 and 3
 (c) 1 and 2 (d) 1 and 3

61. Which of the following shows correct order of bond length?

- (a) $\text{O}_2^+ > \text{O}_2 > \text{O}_2^- > \text{O}_2^{2-}$ (b) $\text{O}_2^+ < \text{O}_2 > \text{O}_2 < \text{O}_2^{2-}$
 (c) $\text{O}_2^+ > \text{O}_2 < \text{O}_2^- > \text{O}_2^{2-}$ (d) $\text{O}_2^+ > \text{O}_2 < \text{O}_2^- > \text{O}_2^{2-}$

62. The number of radial nodes of 3s and 2p orbitals are respectively

- (a) 2, 0 (b) 0, 2
 (c) 1, 2 (d) 2, 2

63. If a 25.0 mL sample of sulfuric acid is titrated with 50.0 mL of 0.025 M sodium hydroxide to a phenolphthalein endpoint, what is the molarity of the acid?

- (a) 0.020 M (b) 0.100 M
 (c) 0.025 M (d) 0.050 M

64. Find which of the following compound can have mass ratios of C:H:O as 6:1:24

- (a) $\text{HO}-(\text{C}=\text{O})-\text{OH}$ (b) $\text{HO}-(\text{C}=\text{O})-\text{H}$
 (c) $\text{H}-(\text{C}=\text{O})-\text{H}$ (d) $\text{H}_3\text{CO}-(\text{C}=\text{O})-\text{H}$

65. The number of atoms per unit cell of bcc structure is

- (a) 1 (b) 2
 (c) 4 (d) 6

66. Which of these doesn't exist?

- (a) PH_3 (b) PH_5
 (c) LuH_3 (d) PF_5

67. Which of these compounds are directional?

- (a) NaCl (b) CO_2
 (c) BaO (d) CsCl_2

68. For a given reaction, $\Delta H = 35.5 \text{ kJ mol}^{-1}$ and $\Delta S = 83.6 \text{ JK}^{-1} \text{ mol}^{-1}$. The reaction is spontaneous at : (Assume that ΔH and ΔS do not vary with temperature)

- (a) $T > 425 \text{ K}$ (b) All temperatures
 (c) $T > 298 \text{ K}$ (d) $T < 425 \text{ K}$

69. Specific conductance of 0.1 MHA is $3.75 \times 10^{-4} \text{ ohm}^{-1} \text{ cm}^{-1}$.

If $\lambda^\infty(\text{HA}) = 250 \text{ ohm}^{-1} \text{ cm}^2 \text{ mol}^{-1}$, the dissociation constant K_a of HA is :

- (a) 1.0×10^{-5} (b) 2.25×10^{-4}
 (c) 2.25×10^{-5} (d) 2.25×10^{-13}

70. The rate of reaction between two reactants A and B decreases by a factor of 4 if the concentration of reactant B is doubled. The order of this reaction with respect to reactant B is:

- (a) 2 (b) -2
 (c) 1 (d) -1

71. A compound of molecular formula of C_7H_{16} shows optical isomerism, compound will be

- (a) 2,3-Dimethylpentane
 (b) 2,2-Dimethylbutane
 (c) 3-Methylhexane
 (d) None of the above

72. Which of the following does not contain Plane of symmetry?

- (a) trans-1,3 dichloro cyclohexane
- (b) trans-1,2 dichloro cyclohexane
- (c) cis-1,2 dichloro cyclohexane
- (d) trans-1,3 cyclopentane

73. Cadmium is used in nuclear reactors for?

- (a) absorbing neutrons
- (b) cooling
- (c) release neutrons
- (d) increase energy

74. Which reagent converts nitrobenzene to N-phenyl hydroxyamine?

- (a) Zn/HCl
- (b) H_2O_2
- (c) Zn/ NH_4Cl
- (d) $LiAlH_4$

75. Which of the following can act as both Bronsted acid and Bronsted base?

- (a) Na_2CO_3
- (b) OH^-
- (c) HCO_3^-
- (d) NH_3

76. Identify the structure of water in the gaseous phase.

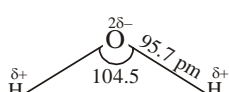
- (a) $H - \ddot{O} - H$
- (b) $H - \overset{+}{O} - H$
 |
 H
- (c) 
- (d) None of these

77. Electrometallurgical process is used to extract

- (a) Fe
- (b) Pb
- (c) Na
- (d) Ag

78. The correct statement about the compounds A, B, and C

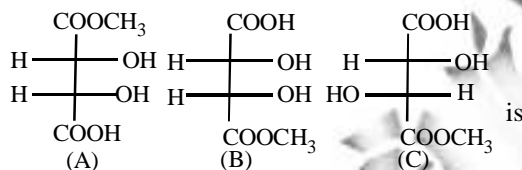

- (a) A and B are identical
- (b) A and B are diastereomers
- (c) A and C are enantiomers
- (d) A and B are enantiomers

79. Correct formula of the complex formed in the brown ring test for nitrates is

- (a) $FeSO_4 \cdot NO$
- (b) $[Fe(H_2O)_5NO]^{2+}$
- (c) $[Fe(H_2O)_5NO]^+$
- (d) $[Fe(H_2O)_5NO]^{3+}$

80. Which one of the following is an amine hormone ?

- (a) Thyroxine
- (b) Oxypurin
- (c) Insulin
- (d) Progesterone

PART - III (A) : ENGLISH PROFICIENCY

DIRECTIONS (Qs. 81): In the following question, out of the four alternatives, choose the one which best expresses the meaning of the given word.

81. Loquacious

- (a) Talkative
- (b) Slow
- (c) Content
- (d) Unclear

DIRECTIONS (Qs. 82): Choose the word opposite in meaning to the given word.

82. Meticulous

- (a) Forgetful
- (b) Destructive
- (c) Careless
- (d) Flagrant

DIRECTIONS (Qs. 83 - 86): In the following questions, you have two brief passages with 5 questions in each passage. Read the passage carefully and choose the best answer to each question out of the four alternatives.

PASSAGE-I

To write well you have to be able to write clearly and logically, and you cannot do this unless you can think clearly and logically. If you cannot do this yet you should train yourself to do it by taking particular problems and following them through, point by point, to a solution, without leaving anything out and without avoiding any difficulties that you meet.

At first you find clear, step-by-step thought very difficult. You may find that your mind is not able to concentrate. Several unconnected ideas may occur together. But practice will improve your ability to concentrate on a single idea and think about it clearly and logically. In order to increase your vocabulary and to improve your style, you should read widely and use a good dictionary to help you find the exact meanings and correct usages of words.

Always remember that regular and frequent practice is necessary if you want to learn to write well. It is no good waiting until you have an inspiration before you write. Even with the most famous writers, inspiration is rare. Someone said that writing is ninety-nine percent hard work and one percent inspiration, so the sooner you get into the habit of disciplining your-self to write, the better.

83. To write well, a person must train himself in

- (a) dealing with a difficult problem
- (b) not leaving anything out
- (c) thinking clearly and logically
- (d) following a step-by-step approach

84. Initially it is difficult to write because

- (a) a good dictionary is not used
- (b) ideas occur without any sequence
- (c) aids to correct writing are not known
- (d) exact usages of words are not known

85. According to the passage, writing style can be improved by

- (a) thinking logically
- (b) writing clearly
- (c) undergoing training
- (d) reading widely

86. Famous writers have achieved success by

- (a) using their linguistic resources properly
- (b) disciplining their skill
- (c) following only one idea
- (d) waiting for inspiration

DIRECTIONS (Qs. 87-88) : In questions below, sentences are given with blanks to be filled in with an appropriate word (s). Four alternatives are suggested for each question. Choose the correct alternative out of the four.

87. China is a big country, in area it is bigger than any other country _____ Russia.
 (a) accept (b) except
 (c) expect (d) access
88. The treasure was hidden _____ a big shore.
 (a) on (b) underneath
 (c) toward (d) off

DIRECTIONS (Qs. 89-90) : In questions, some parts of the sentences have errors and some are correct. Find out which part of a sentence has an error. If a sentence is free from error, mark (d) in your Answer.

89. My father gave me (a) / a pair of binocular (b) / on my birthday. (c) / No error. (d)
90. The teacher as well as his students, (a) / all left (b) / for the trip. (c) / No error. (d)

PART - III (B) : LOGICAL REASONING

91. Which answer figure complete the form in question figure ?

Question figure :

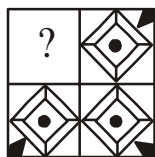

Answer figures :

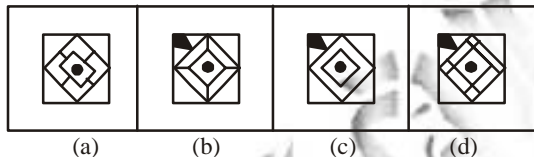

DIRECTIONS (Q. 92): In the following question which answer figure will complete the question figure?

92. **Question figure:**



Answer figures:

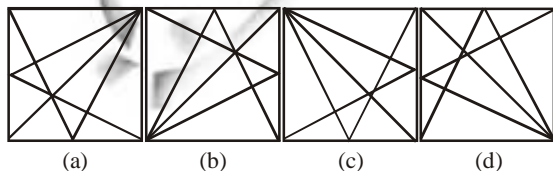

93. Which answer figure includes all the components given in the question figure ?

Question Figure :

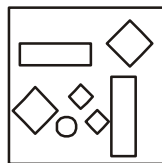

Answer Figures :

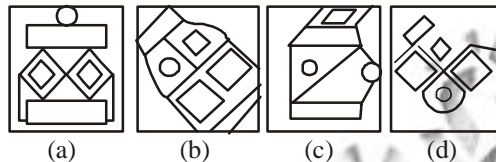

94. Which of the answer figures include the separate components found in the question figure?

Question figure:

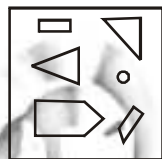

Answer figures:

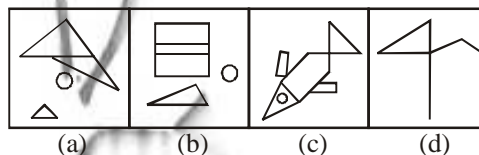

DIRECTIONS (Qs. 95-96): Select a suitable figure from the four alternatives that would complete the figure matrix.

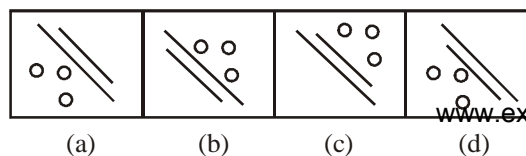
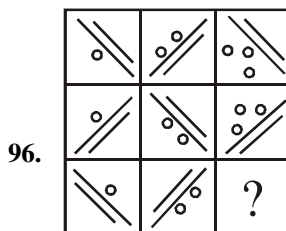
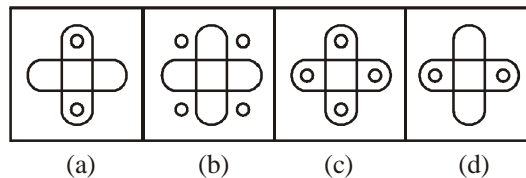
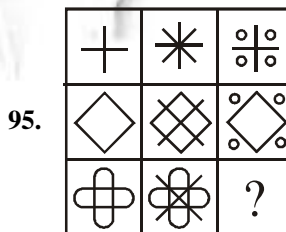

97. M is the son of P. Q is the grand daughter of O who is the husband of P. How is M related to O?
 (a) Son (b) Daughter
 (c) Mother (d) Father
98. Vinod introduces Vishal as the son of the only brother of his father's wife. How is Vinod related to Vishal?
 (a) Cousin (b) Brother
 (c) Son (d) Uncle
99. AGMSY, CIOUA, EKQWC, ? IOUAG, KQWCI
 (a) GMSYE (b) FMSYE
 (c) GNSYD (d) FMYES
100. (?), PSVYB, EHKNQ, TWZCF, ILORU
 (a) BEHKN (b) ADGJM
 (c) SVYBE (d) ZCFIL

DIRECTIONS (Qs. 101) : In the following question, one statement is given followed by two assumptions I and II. You have to consider the statement to be true even if it seems to be at variance from commonly known facts. You have to decide which of the given assumptions, if any, follow from the given statement.

101. Statements : Politicians become rich by the votes of the people.

Assumptions :

- I. People vote to make politicians rich.
 II. Politicians become rich by their virtue.

- (a) Only I is implicit
 (b) Only II is implicit
 (c) Both I and II are implicit
 (d) Both I and II are not implicit

102. Two statements are given followed by four conclusions, I, II, III and IV. You have to consider the statements to be true, even if they seem to be at variance from commonly known facts. You have to decide which of the given conclusions can definitely be drawn from the given statements. Indicate your answer.

Statements :

- (A) No cow is a chair
 (B) All chairs are tables.

Conclusions :

- I. Some tables are chairs.
 II. Some tables are cows
 III. Some chairs are cows
 IV. No table is a cow
 (a) Either II or III follow
 (b) Either II or IV follow
 (c) Only I follows
 (d) None of these

DIRECTIONS (Qs. 103-104): In questions one/two statements are given, followed by two conclusions I and II. You have to consider the statements to be true, even if they seem to be at variance from commonly known facts. You have to decide which of the given conclusions, if any follow from the given statement.

103. Statements :

1. Temple is a place of worship.
 2. Church is also a place of worship.

Conclusions :

- I. Hindus and Christians use the same place for worship.
 II. All churches are temples.
 (a) Neither conclusion I and II follows
 (b) Both conclusions I and II follow
 (c) Only conclusion I follows
 (d) Only conclusion II follows

104. Statement :

The human organism grows and develops through stimulation and action.

Conclusions :

- I. Inert human organism cannot grow and develop.
 II. Human organisms do not react to stimulation and action.
 (a) Neither conclusion I nor II follows
 (b) Both conclusions I and II follow
 (c) Only conclusion I follows
 (d) Only conclusion II follows

105. Choose the set of figure which follows the given rule.

Rule: Closed figures gradually become open and open figures gradually become closed.

(1)

(2)

(3)

(4)

(a) (1) (b) (2)
 (c) (3) (d) (4)

PART - IV : MATHEMATICS

106. Let f and g be functions from \mathbb{R} to \mathbb{R} defined as

$$f(x) = \begin{cases} 7x^2 + x - 8, & x \leq 1 \\ 4x + 5, & 1 < x \leq 3 \\ 8x + 3, & x > 3 \end{cases}, \quad g(x) = \begin{cases} |x|, & x \leq 3 \\ 0, & -3 \leq x \leq 2 \\ x^2 + 4, & x \geq 2 \end{cases}$$

Then

- (a) $(f \circ g)(-3) = 8$ (b) $(f \circ g)(9) = 683$
 (c) $(g \circ f)(0) = -8$ (d) $(g \circ f)(6) = 427$

107. How many different nine digit numbers can be formed from the number 223355888 by rearranging its digits so that the odd digits occupy even positions ?

- (a) 16 (b) 36
 (c) 60 (d) 180

108. If $\sum_{k=1}^n k(k+1)(k-1) = pn^4 + qn^3 + tn^2 + sn$, where p, q, t

and s are constants, then the value of s is equal to

- (a) $-\frac{1}{4}$ (b) $-\frac{1}{2}$
 (c) $\frac{1}{2}$ (d) $\frac{1}{4}$

109. The length of the semi-latus rectum of an ellipse is one third of its major axis, its eccentricity would be

- (a) $\frac{2}{3}$ (b) $\sqrt{\frac{2}{3}}$
 (c) $\frac{1}{\sqrt{3}}$ (d) $\frac{1}{\sqrt{2}}$

110. If α and β are roots of the equation $x^2 + px + \frac{3p}{4} = 0$, such

that $|\alpha - \beta| = \sqrt{10}$, then p belongs to the set :

- (a) $\{2, -5\}$ (b) $\{-3, 2\}$
 (c) $\{-2, 5\}$ (d) $\{3, -5\}$

111. Given the system of straight lines $a(2x + y - 3) + b(3x + 2y - 5) = 0$, the line of the system situated farthest from the point $(4, -3)$ has the equation

- (a) $4x + 11y - 15 = 0$ (b) $7x + y - 8 = 0$
 (c) $4x + 3y - 7 = 0$ (d) $3x - 4y + 1 = 0$

112. One mapping is selected at random from all mappings of the set $S = \{1, 2, 3, \dots, n\}$ into itself. The probability that it is

one-one is $\frac{3}{32}$. Then the value of n is

- (a) 3 (b) 4
 (c) 5 (d) 6

113. The integer just greater than $(3 + \sqrt{5})^{2n}$ is divisible by $(n \in \mathbb{N})$

- (a) 2^{n-1} (b) 2^{n+1}
 (c) 2^{n+2} (d) Not divisible by 2

114. The domain of the function

$$f(x) = \sin^{-1} \left\{ \log_2 \left(\frac{1}{2} x^2 \right) \right\} \text{ is}$$

- (a) $[-2, -1] \cup [1, 2]$ (b) $(-2, -1] \cup [1, 2]$
 (c) $[-2, -1] \cup [1, 2]$ (d) $(-2, -1) \cup (1, 2]$

115. The marks obtained by 60 students in a certain test are given below :

| Marks | No. of students | Marks | No. of students |
|-------|-----------------|--------|-----------------|
| 10-20 | 2 | 60-70 | 12 |
| 20-30 | 3 | 70-80 | 14 |
| 30-40 | 4 | 80-90 | 10 |
| 40-50 | 5 | 90-100 | 4 |
| 50-60 | 6 | | |

Median of the above data is

- (a) 68.33 (b) 70
 (c) 68.11 (d) None of these

116. If A, B, C are the angles of a triangle and e^{iA}, e^{iB}, e^{iC} are in A.P. Then the triangle must be

- (a) right angled (b) isosceles
 (c) equilateral (d) None of these

117. An observer on the top of a tree, finds the angle of depression of a car moving towards the tree to be 30° . After 3 minutes this angle becomes 60° . After how much more time, the car will reach the tree?

- (a) 4 min. (b) 4.5 m
 (c) 1.5 min (d) 2 min.

118. After striking the floor a certain ball rebounds $\frac{4}{5}$ th of its

height from which it has fallen. The total distance that the ball travels before coming to rest if it is gently released from a height of 120m is

- (a) 960m (b) 1000m
 (c) 1080m (d) Infinite

119. An equilateral triangle is inscribed in the circle $x^2 + y^2 = a^2$ with one of the vertices at $(a, 0)$. What is the equation of the side opposite to this vertex ?

- (a) $2x - a = 0$ (b) $x + a = 0$
 (c) $2x + a = 0$ (d) $3x - 2a = 0$

120. The function $f(x) = x - |x - x^2|$, $-1 \leq x \leq 1$ is continuous on the interval

- (a) $[-1, 1]$ (b) $(-1, 1)$
 (c) $\{-1, 1\} - \{0\}$ (d) $(-1, 1) - \{0\}$

121. If $\frac{4}{n+1} < \frac{(2n)!}{(n!)^2}$, then P(n) is true for

- (a) $n \geq 1$ (b) $n > 0$
 (c) $n < 0$ (d) $n \geq 2$

122. If a system of equation $-ax + y + z = 0$

$$x - by + z = 0$$

$$x + y - cz = 0 \quad (a, b, c \neq -1)$$

has a non-zero solution then $\frac{1}{1+a} + \frac{1}{1+b} + \frac{1}{1+c} =$

- (a) 0 (b) 1
 (c) 2 (d) 3

123. If $f(x) = x^x$, then $f(x)$ is increasing in interval :

- (a) $[0, e]$ (b) $[0, \frac{1}{e}]$
 (c) $[0, 1]$ (d) None of these

124. If x is real number, then $\frac{x}{x^2 - 5x + 9}$ must lie between

- (a) $\frac{1}{11}$ and 1 (b) -1 and $\frac{1}{11}$
 (c) -11 and 1 (d) $-\frac{1}{11}$ and 1

125. The value of $\lim_{x \rightarrow 0} \left(\frac{a_1^{1/x} + a_2^{1/x} + \dots + a_n^{1/x}}{n} \right)^{nx}$

$a_i > 0, i = 1, 2, \dots, n$, is

- (a) $a_1 + a_2 + \dots + a_n$ (b) $e^{a_1 + a_2 + \dots + a_n}$
 (c) $\frac{a_1 + a_2 + \dots + a_n}{n}$ (d) $a_1 a_2 a_3 \dots a_n$

126. The value of $\cot^{-1} 7 + \cot^{-1} 8 + \cot^{-1} 18$ is

- (a) π (b) $\frac{\pi}{2}$
 (c) $\cot^{-1} 5$ (d) $\cot^{-1} 3$

127. If $\int \frac{\cos x - 1}{\sin x + 1} e^x dx$ is equal to :

- (a) $\frac{e^x \cos x}{1 + \sin x} + C$ (b) $C - \frac{e^x \sin x}{1 + \sin x}$
 (c) $C - \frac{e^x}{1 + \sin x}$ (d) $C - \frac{e^x \cos x}{1 + \sin x}$

128. A random variable X has the probability distribution

| | | | | | | | | |
|------|------|------|------|------|------|------|------|------|
| X | 1 | 2 | 3 | 4 | 5 | 6 | 7 | 8 |
| p(X) | 0.15 | 0.23 | 0.12 | 0.10 | 0.20 | 0.08 | 0.07 | 0.05 |

For the events $E = \{X \text{ is a prime number}\}$ and $F = \{X < 4\}$, then $P(E \cap F)$ is

- (a) 0.50 (b) 0.77
 (c) 0.35 (d) 0.87

129. The number of roots of equation $\cos x + \cos 2x + \cos 3x = 0$ is ($0 \leq x \leq 2\pi$)

- (a) 4 (b) 5
 (c) 6 (d) 8

130. The area under the curve $y = |\cos x - \sin x|, 0 \leq x \leq \frac{\pi}{2}$, and above x-axis is :

- (a) $2\sqrt{2}$ (b) $2\sqrt{2} - 2$
 (c) $2\sqrt{2} + 2$ (d) 0

131. If $f(x) = \begin{cases} \frac{x \log \cos x}{\log(1+x^2)}, & x \neq 0 \\ 0, & x = 0 \end{cases}$ then $f(x)$ is

- (a) continuous as well as differentiable at $x = 0$
 (b) continuous but not differentiable at $x = 0$
 (c) differentiable but not continuous at $x = 0$
 (d) neither continuous nor differentiable at $x = 0$

132. The maximum value of $z = 3x + 2y$ subject to $x + 2y \leq 2, x + 2y \leq 8, x, y \geq 0$ is :

- (a) 32 (b) 24
 (c) 40 (d) None of these

133. A cylindrical gas container is closed at the top and open at

the bottom. if the iron plate of the top is $\frac{5}{4}$ time as thick as the plate forming the cylindrical sides. The ratio of the radius to the height of the cylinder using minimum material for the same capacity is

- (a) $\frac{2}{3}$ (b) $\frac{1}{2}$
 (c) $\frac{4}{5}$ (d) $\frac{1}{3}$

134. Let A, B, C be finite sets. Suppose that $n(A) = 10, n(B) = 15, n(C) = 20, n(A \cap B) = 8$ and $n(B \cap C) = 9$. Then the possible value of $n(A \cup B \cup C)$ is

- (a) 26
 (b) 27
 (c) 28
 (d) Any of the three values 26, 27, 28 is possible

135. If $f(z) = \frac{7-z}{1-z^2}$, where $z = 1 + 2i$, then $|f(z)|$ is equal to :

- (a) $\frac{|z|}{2}$ (b) $|z|$
 (c) $2|z|$ (d) None of these

136. If $f(x) = \cos^{-1} \left[\frac{1 - (\log x)^2}{1 + (\log x)^2} \right]$ then the value of $f'(e)$ is equal to

- (a) 1 (b) $\frac{1}{e}$
 (c) $\frac{2}{e}$ (d) $\frac{2}{e^2}$

137. **Statement 1** : A five digit number divisible by 3 is to be formed using the digits 0, 1, 2, 3, 4 and 5 with repetition. The total number formed are 216.

Statement 2 : If sum of digits of any number is divisible by 3 then the number must be divisible by 3.

- (a) Statement-1 is true, Statement-2 is true, Statement-2 is a correct explanation for Statement - 1
 (b) Statement - 1 is true, Statement - 2 is true ; Statement-2 is NOT a correct explanation for Statement - 1
 (c) Statement - 1 is true, Statement- 2 is false
 (d) Statement - 1 is false, Statement - 2 is true

138. The equation of one of the common tangents to the parabola $y^2 = 8x$ and $x^2 + y^2 - 12x + 4 = 0$ is

- (a) $y = -x + 2$ (b) $y = x$ www.examrace.com
 (c) $y = x + 2$ (d) None of these

139. If $R(t) = \begin{bmatrix} \cos t & \sin t \\ -\sin t & \cos t \end{bmatrix}$, then $R(s)R(t)$ equals

- (a) $R(s+t)$ (b) $R(s-t)$
 (c) $R(s) \neq R(t)$ (d) None of these

140. If $\int x \log \left(1 + \frac{1}{x}\right) dx = f(x) \log(x) + \frac{1}{2}g(x)x^2 + Lx + C$, then

- (a) $f(x) = \frac{1}{2}x^2$ (b) $g(x) = \log x$
 (c) $L=1$ (d) None of these

141. Let \vec{a} , \vec{b} & \vec{c} be non-coplanar unit vectors equally inclined to one another at an acute angle θ . Then $|\vec{a} \cdot \vec{b} \cdot \vec{c}|$ in terms of θ is equal to

- (a) $(1 + \cos \theta) \sqrt{\cos 2\theta}$
 (b) $(1 + \cos \theta) \sqrt{1 - 2\cos 2\theta}$
 (c) $(1 - \cos \theta) \sqrt{1 + 2\cos 2\theta}$
 (d) None of these

142. $2^{1/4}, 2^{2/8}, 2^{3/16}, 2^{4/32}, \dots, \infty$ is equal to-

- (a) 1 (b) 2
 (c) $3/2$ (d) $5/2$

143. If $\sum_{r=0}^n (-1)^r \frac{{}^n C_r}{r+3} = \frac{3}{a+3}$, then $a-n$ is equal to

- (a) 0 (b) 1
 (c) 2 (d) None of these

144. If $\begin{vmatrix} p & q-y & r-z \\ p-x & q & r-z \\ p-x & q-y & r \end{vmatrix} = 0$, then the value of $\frac{p}{x} + \frac{q}{y} + \frac{r}{z}$ is

- (a) 0 (b) 1
 (c) 2 (d) $4pqr$

145. An urn contains five balls. Two balls are drawn and found to be white. The probability that all the balls are white is

- (a) $\frac{1}{10}$ (b) $\frac{3}{10}$
 (c) $\frac{3}{5}$ (d) $\frac{1}{2}$

146. The ratio in which the join of $(2, 1, 5)$ and $(3, 4, 3)$ is divided by the plane $(x + y - z) = \frac{1}{2}$ is:

- (a) 3:5 (b) 5:7
 (c) 1:3 (d) 4:5

147. Value of $\int_0^{\pi/2} \frac{\sqrt{\sin x}}{\sqrt{\sin x} + \sqrt{\cos x}} dx$ is

- (a) $\frac{\pi}{2}$ (b) $\frac{-\pi}{2}$
 (c) $\frac{\pi}{4}$ (d) None of these

148. The dot product of a vector with the vectors $\hat{i} + \hat{j} - 3\hat{k}$, $\hat{i} + 3\hat{j} - 2\hat{k}$ and $2\hat{i} + \hat{j} + 4\hat{k}$ are 0, 5 and 8 respectively. The vector is

- (a) $\hat{i} + 2\hat{j} + \hat{k}$ (b) $-\hat{i} + 3\hat{j} - 2\hat{k}$
 (c) $\hat{i} + 2\hat{j} + 3\hat{k}$ (d) $\hat{i} - 3\hat{j} - 3\hat{k}$

149. The angle between the lines whose intercepts on the axes are $a, -b$ and $b, -a$ respectively, is

- (a) $\tan^{-1} \frac{a^2 - b^2}{ab}$ (b) $\tan^{-1} \frac{b^2 - a^2}{2}$
 (c) $\tan^{-1} \frac{b^2 - a^2}{2ab}$ (d) None of these

150. If the line through the points $A(k, 1, -1)$ and $B(2k, 0, 2)$ is perpendicular to the line through the points B and $C(2 + 2k, k, 1)$, then what is the value of k ?

- (a) -1 (b) 1
 (c) -3 (d) 3

SOLUTIONS

PART - I : PHYSICS

1. (a) As we know,

$$\text{Gravitational potential energy} = \frac{-GMm}{r}$$

and orbital velocity, $v_0 = \sqrt{GM/(R+h)}$

$$= \sqrt{\frac{GM}{(R+2R)}} = \sqrt{\frac{GM}{3R}}$$

$$E_f = \frac{1}{2}mv_0^2 - \frac{GMm}{3R} = \frac{1}{2}m\frac{GM}{3R} - \frac{GMm}{3R}$$

$$= \frac{GMm}{3R} \left(\frac{1}{2} - 1 \right) = \frac{-GMm}{6R}$$

$$E_i = \frac{-GMm}{R} + K$$

$$E_i = E_f$$

Therefore minimum required energy, $K = \frac{5GMm}{6R}$

2. (a) $W = T_\Delta A = 4\pi R^2 T(n^{1/3} - 1)$
 $= 4 \times 3.14 \times (10^{-2})^2 \times 460 \times 10^{-3} [(10^6)^{1/3} - 1] = 0.057$

3. (c) $\frac{1}{f_1} = \left(\frac{3}{2} - 1 \right) \left(\frac{1}{\infty} - \frac{1}{25} \right) = -\frac{1}{50}$,

$$\frac{1}{f_2} = \left(\frac{4}{3} - 1 \right) \left(\frac{1}{25} + \frac{1}{20} \right) = \frac{3}{100}$$

and $\frac{1}{f_3} = \left(\frac{3}{2} - 1 \right) \left(\frac{1}{-20} - \frac{1}{\infty} \right) = -\frac{1}{40}$

Now $\frac{1}{f} = \frac{1}{f_1} + \frac{1}{f_2} + \frac{1}{f_3}$

$$= -\frac{1}{50} + \frac{3}{100} - \frac{1}{40}$$

$$\therefore f = -66.6 \text{ cm}$$

4. (b) When a charged particle enters a magnetic field at a direction perpendicular to the direction of motion, the path of the motion is circular. In circular motion the

direction of velocity changes at every point (the magnitude remains constant).

Therefore, the tangential momentum will change at every point. But kinetic energy will remain constant as it is given by $\frac{1}{2}mv^2$ and v^2 is the square of the magnitude of velocity which does not change.

5. (b) $N = N_0 \left(\frac{1}{2} \right)^n$

or $\frac{N_0}{16} = N_0 \left(\frac{1}{2} \right)^n$

or $n = 4$

Half life $t_{1/2} = \frac{t}{n} = \frac{2}{4} = \frac{1}{2} \text{ h}$

6. (a) The charging of inductance given by,

$$i = i_0 \left(1 - e^{-\frac{Rt}{L}} \right)$$

$$\frac{i_0}{2} = i_0 \left(1 - e^{-\frac{Rt}{L}} \right) \Rightarrow e^{-\frac{Rt}{L}} = \frac{1}{2}$$

Taking log on both the sides,

$$-\frac{Rt}{L} = \log 1 - \log 2$$

$$\Rightarrow t = \frac{L}{R} \log 2 = \frac{300 \times 10^{-3}}{2} \times 0.69 \Rightarrow t = 0.1 \text{ sec.}$$

7. (a) For, $r < r_A$, $E = 0$

$$r = r_A, \quad E = \frac{1}{4\pi\epsilon_0} \frac{Q_A}{r_A^2}$$

$$r_A < r < r_B, \quad E = \frac{1}{4\pi\epsilon_0} \frac{Q_A}{r^2}$$

$$r = r_B, \quad E = \frac{1}{4\pi\epsilon_0} \left(\frac{Q_A - Q_B}{r_B^2} \right)$$

$$= -\frac{1}{4\pi\epsilon_0} \left(\frac{Q_B - Q_A}{r_B^2} \right)$$

These values are correctly represent in option (a).

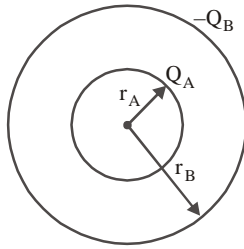

8. (b)
$$M = (\pi r^2 h) \rho = \pi r^2 \left(\frac{2T \cos \theta}{\rho r g} \right) \rho$$

and
$$M = \pi (2r)^2 \left(\frac{2T \cos \theta}{\rho \times 2r \times g} \right) \rho$$

$$= 2M.$$

9. (a)
$$f = \frac{5}{2\ell} \sqrt{\frac{F}{\mu}} = \frac{5}{2\ell} \sqrt{\frac{9g}{\mu}}$$
(i)

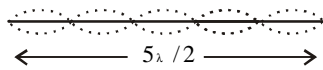

and
$$f = \frac{3}{2\ell} \sqrt{\frac{Mg}{\mu}}$$
(ii)

From above equations, we get $M = 25 \text{ kg}$.

10. (a) We have, $E = W_0 + K$

or $\frac{hc}{400 \times 10^9} = W_0 + \frac{1}{2}mv^2$... (i)

and $\frac{hc}{250 \times 10^9} = W_0 + \frac{1}{2}m(2v)^2$... (ii)

On simplifying above equations, we get

$$W_0 = 2hc \times 10^6 \text{ J.}$$

11. (d) $V = 0$, and so $C = \frac{q}{V} \rightarrow \infty$.

12. (d) Mass of uranium changed into energy

$$= \frac{0.1}{100} \times 1$$

$$= 10^{-3} \text{ kg.}$$

The energy released $= mC^2$
 $= 10^{-3} \times (3 \times 10^8)^2$
 $= 9 \times 10^{13} \text{ J.}$

13. (d) The change in internal energy ΔU is same in all process.

$$Q_{ACB} = \Delta U + W_{ACB},$$

$$Q_{ADB} = \Delta U,$$

$$Q_{AEB} = \Delta U + W_{AEB}$$

Here W_{ACB} is positive and W_{AEB} is negative.

Hence $Q_{ACB} > Q_{ADB} > Q_{AEB}$.

14. (c) Dimensions of $Y = \frac{\text{dimensions of } X}{\text{dimensions of } Z^2}$

$$= \frac{M^{-1}L^{-2}T^4A^2}{(MT^{-2}A^{-1})^2}$$

$$= [M^{-3}L^{-2}T^8A^4]$$

15. (d) Net magnetic field due to the wires will be downward as shown below in the figure. Since angle between \vec{v} and \vec{B} is 180° ,

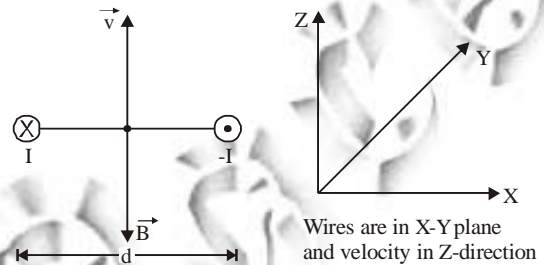

Therefore, magnetic force $\vec{F}_m = q(\vec{v} \times \vec{B}) = 0$

16. (c) For projectile A

Maximum height, $H_A = \frac{u_A^2 \sin^2 45^\circ}{2g}$

For projectile B

Maximum height, $H_B = \frac{u_B^2 \sin^2 \theta}{2g}$

As we know, $H_A = H_B$

$$\frac{u_A^2 \sin^2 45^\circ}{2g} = \frac{u_B^2 \sin^2 \theta}{2g}$$

$$\frac{\sin^2 \theta}{\sin^2 45^\circ} = \frac{u_A^2}{u_B^2}$$

$$\sin^2 \theta = \left(\frac{u_A}{u_B} \right)^2 \sin^2 45^\circ$$

$$\sin^2 \theta = \left(\frac{1}{\sqrt{2}} \right)^2 \left(\frac{1}{\sqrt{2}} \right)^2 = \frac{1}{4}$$

$$\sin \theta = \frac{1}{2} \Rightarrow \theta = \sin^{-1} \left(\frac{1}{2} \right) = 30^\circ$$

17. (b) At Null point

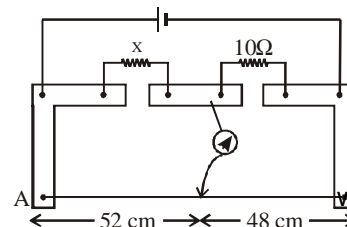

$$\frac{X}{l_1} = \frac{10}{l_2}$$

Here $l_1 = 52 + \text{End correction} = 52 + 1 = 53 \text{ cm}$

$l_2 = 48 + \text{End correction} = 48 + 2 = 50 \text{ cm}$

$$\therefore \frac{X}{53} = \frac{10}{50} \quad \therefore X = \frac{53}{5} = 10.6 \text{ cm}$$

18. (a) Total flux through the cubical surface,

$$\begin{aligned} \phi &= \frac{q_{\text{in}}}{\epsilon_0} \\ &= \left[\frac{3 + 2 + (-7)}{\epsilon_0} \right] C = -\frac{2C}{\epsilon_0} \end{aligned}$$

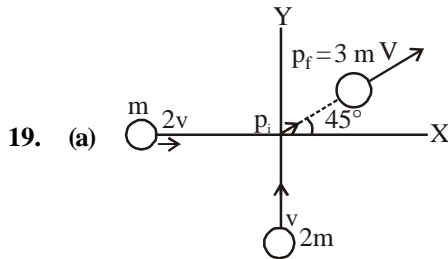

Initial momentum of the system

$$\begin{aligned} p_i &= m \times 2\hat{v}_1 + 2m \times \hat{v}_2 \\ &= \sqrt{(m \times 2v)^2 + (2m \times v)^2} \quad (\text{magnitude}) \\ &= 2\sqrt{2} \text{ mv} \end{aligned}$$

Final momentum of the system = $3mV$

By the law of conservation of momentum

$$2\sqrt{2}mv = 3mV$$

$$\Rightarrow \frac{2\sqrt{2}v}{3} = V_{\text{combined}}$$

Loss in energy

$$\Delta E = \frac{1}{2}m_1V_1^2 + \frac{1}{2}m_2V_2^2 - \frac{1}{2}(m_1 + m_2)V_{\text{combined}}^2$$

$$\Delta E = 3mv^2 - \frac{4}{3}mv^2 = \frac{5}{3}mv^2 = 55.55\%$$

20. (d) Because of the Lenz's law of conservation of energy.

21. (c) We know that

$$Y = \frac{mg/A}{\Delta\ell/\ell} = \frac{mg\ell}{A\Delta\ell} \quad \dots(1)$$

$$\text{Also } \Delta\ell = \ell \alpha \Delta T \quad \dots(2)$$

From (1) and (2)

$$Y = \frac{mg\ell}{A\ell \alpha \Delta T} = \frac{mg}{A\alpha \Delta T}$$

$$\therefore m = \frac{YA\alpha \Delta T}{g} = \frac{10^{11} \times \pi (10^{-3})^2 \times 10^5 \times 10}{10} = \pi = 3$$

22. (a) $C_{\text{max}} = 60^\circ$

$$\therefore r^{\mu} d = \frac{1}{\sin 60^\circ}$$

$$\text{or } \frac{\mu_g}{\mu_\ell} = \frac{2}{\sqrt{3}}$$

$$\begin{aligned} \therefore \mu_\ell &= \frac{\sqrt{3}}{2} \mu_g = \frac{\sqrt{3}}{2} \times 1.5 \\ &= 1.3 \end{aligned}$$

23. (c) The frequency of tuning fork, $f = 392 \text{ Hz}$.

$$\text{Also } 392 = \frac{1}{2 \times 50} \sqrt{F/\mu} \quad \dots\dots(i)$$

After decreasing the length by 2%, we have

$$f' = \frac{1}{2(49)} \sqrt{F/\mu} \quad \dots\dots(ii)$$

From above equations,

$$f' = 400 \text{ Hz}$$

\therefore Beats frequency = 8 Hz.

24. (a) $Z_1 = 1, Z_2 = 1, Z_3 = 2$ and $Z_4 = 3$.

$$\frac{1}{\lambda} = RZ^2 \left(\frac{1}{1^2} - \frac{1}{2^2} \right)$$

$$\text{or } \lambda = \frac{4}{3RZ^2}$$

$$\text{or } \lambda Z^2 = \text{constant}$$

$$\text{So } \lambda_1(1)^2 = \lambda_2(1)^2 = \lambda_3(2)^2 = \lambda_4(3)^2$$

$$\text{or } \lambda_1 = \lambda_2 = 4\lambda_3 = 9\lambda_4$$

25. (a)

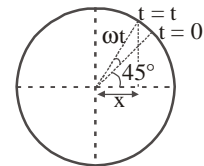

$$x = a \cos \left(\omega t + \frac{\pi}{4} \right)$$

$$\text{or } x = a \cos \left(\frac{2\pi t}{4} + \frac{\pi}{4} \right)$$

26. (b) $\Delta x_{\text{max}} = 0$ and $\Delta x_{\text{max}} = 2\lambda$

Theoretical maximas are $= 2n + 1 = 2 \times 2 + 1 = 5$

But on the screen there will be three maximas.

27. (d) The net resistance of the circuit is 9Ω as shown in the following figures.

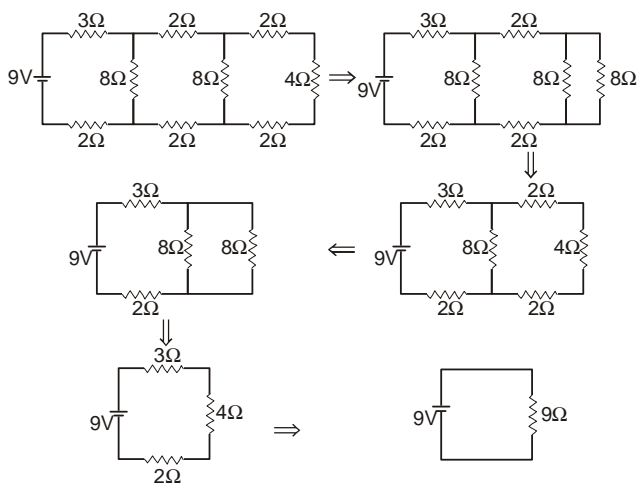

$$I = \frac{V}{R} = \frac{9V}{9\Omega} = 1.0 \text{ A}$$

The flow of current in the circuit is as follows.

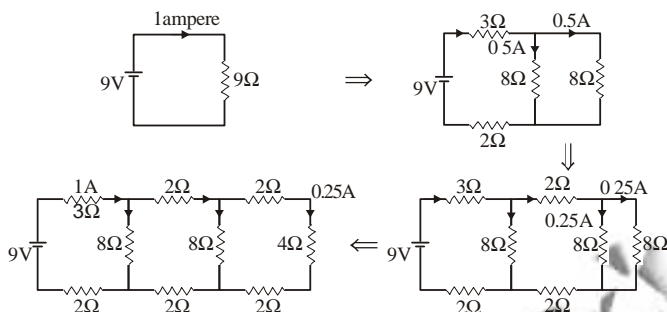

The current divides into two equal parts if it passes through two equal resistances in parallel.

Thus current through 4Ω resistor is 0.25 A .

28. (d) Here $\frac{x}{1000} = \frac{1.22\lambda}{D}$ or $x = \frac{1.22 \times 5 \times 10^3 \times 10^{-10} \times 10^3}{10 \times 10^{-2}}$

$$\text{or } x = 1.22 \times 5 \times 10^{-3} \text{ m} = 6.1 \text{ m}$$

x is of the order of 5 mm.

29. (d) The change of state from liquid to vapour (for gas) is called **vapourisation**. It is observed that when liquid is heated, the temperature remains constant until the entire amount of the liquid is converted into vapour.

The temperature at which the liquid and the vapour states of the substance coexist is called its **boiling point**.

30. (d) When the wire is bent in the form of a square and connected between M and N as shown in fig. (2), the effective resistance between M and N decreases to one fourth of the value in fig. (1). The current increases four times the initial value according to the relation $V = IR$. Since $H = I^2 Rt$, the decrease in the value of resistance is more than compensated by the increase in the value of current. Hence heat produced increases. Percentage loss in energy during the collision $\approx 56\%$

31. (a) $U = mv = kmr$.

$$\text{Force, } F = -\frac{dU}{dr} = -km$$

$$\text{Now, } \frac{mv^2}{r} = km \Rightarrow v \propto r^{1/2}$$

$$\therefore T = \frac{2\pi r}{v} = \frac{2\pi r}{cr^{1/2}} \Rightarrow T \propto r^{1/2}$$

32. (b) $\sin \theta = \frac{1}{2}$

Thus, $N_1 \sin \theta = N_2$

$$\therefore \frac{N_1}{N_2} = \frac{1}{\sin \theta} = 2.$$

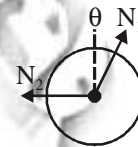

33. (a) When charge is given to inner cylinder, an electric field will be in between the cylinders. So there is potential difference between the cylinders.

34. (a) $\frac{x}{\sin 2\theta} = \frac{r}{\sin(90^\circ - \theta)}$

$$x = 2r \sin \theta$$

$$\frac{dx}{dt} = 2r \cos \theta \times \frac{d\theta}{dt}$$

$$\frac{d\theta}{dt} = \frac{dx/dt}{2r \cos \theta} = \frac{v_0}{2r \cos 60^\circ} = \frac{v_0}{r}$$

35. (c) $R^2 = [A^2 + B^2 + 2AB \cos \theta]$

$$R^2 = R^2 + R^2 + 2R^2 \cos \theta$$

$$-R^2 = 2R^2 \cos \theta \text{ or } \cos \theta = -1/2 \text{ or } \theta = 2\pi/3$$

36. (b) $B = \mu_0 \mu_r H \Rightarrow \mu_r \mu_r \frac{B}{H} = \text{slope of B-H curve}$

According to the given graph, slope of the graph is highest at point Q.

37. (b) $v_{av} = \left[\frac{500 + 600 + 700 + 800 + 900}{5} \right] = 700 \text{ m/s}$

and

$$v_{rms} = \sqrt{\frac{500^2 + 600^2 + 700^2 + 800^2 + 900^2}{5}} = 714 \text{ m/s}$$

Thus v_{rms} is greater than average speed by 14 m/s.

38. (b) The effective circuit is shown in figure.

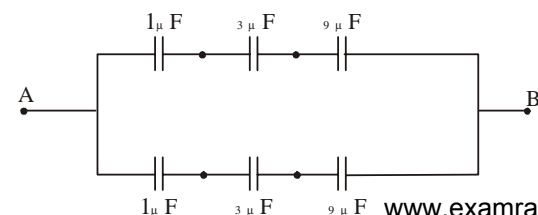

The capacitance of upper series,

$$\frac{1}{C} = \frac{1}{1} + \frac{1}{3} + \frac{1}{9} + \frac{1}{27} + \dots$$

$$\therefore C = \frac{2}{3} \mu\text{C}$$

$$\text{Now } C_{AB} = 2C = \frac{4}{3} \mu\text{F}$$

39. (a) Process AB is isobasic and BC is isothermal, CD isochoric and DA isothermic compression.
40. (d) During the operation, either of D_1 and D_2 be in forward bias. Also R_1 and R_2 are different, so output across R will have different peaks.

PART - II : CHEMISTRY

41. (b) Polystyrene and polyethylene belong to the category of thermoplastic polymers which are capable of repeatedly softening on heating and harden on cooling.

42. (d) Hybridisation :

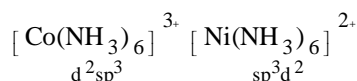
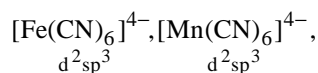

Hence $[\text{Ni}(\text{NH}_3)_6]^{2+}$ is outer orbital complex.

43. (a) The order of reaction is $\frac{3}{2}$ and molecularity is 2.
44. (d) CaSO_4
45. (a) More is E_{RP}° , more is the tendency to get itself reduced or more is oxidising power.
46. (c) $\Delta G = -2.303 RT \log K$
 $-nFE^\circ = -2.303 RT \log K$

$$\log K = \frac{nFE^\circ}{2.303 RT}$$

$$= 0.4342 \frac{nFE^\circ}{RT} \quad \dots\dots (i)$$

$$\ln K = \frac{nFE^\circ}{RT}$$

$$K = e^{\frac{nFE^\circ}{RT}} \quad \dots\dots (ii)$$

47. (c)
- | Compound | O.S. of N |
|----------------------|-----------|
| N_2O | +1 |
| NO | +2 |
| NO_2 | +4 |
| NO_3^- | +5 |
| NH_4^+ | -3 |

Therefore increasing order of oxidation state of N is:



48. (a) Raoult's law becomes special case of Henry's law when K_H become equal to p_1° .

49. (b) $E_{\text{cell}}^\circ = \frac{0.059}{2} \log K_c$ or $\frac{1.10 \times 2}{0.059} = \log K_c$

$$\therefore K_c = 1.9 \times 10^{37}$$

50. (d) $\frac{P}{T} = \text{constant}$ (Gay Lussac's law)

$$\Rightarrow \frac{P_1}{T_1} = \frac{P_2}{T_2} \Rightarrow P_1 T_2 = P_2 T_1$$

PV = constant

$$P_1 V_1 = P_2 V_2 \quad [\text{Boyle's law}]$$

51. (b) $\Delta n = -\frac{1}{2}$; $\Delta H = \Delta E - \frac{1}{2} RT$; $\Rightarrow \Delta E > \Delta H$

52. (d) For H atom, $E_n = -\frac{13.6Z^2}{n^2} \text{eV}$

For second orbit, $n = 2$

$Z = \text{At. no.} = 1$ (for hydrogen)

$$\therefore E_2 = -\frac{13.6 \times (1)^2}{(2)^2} = -\frac{13.6}{4} \text{eV}$$

$$= \frac{-13.6 \times 1.6 \times 10^{-19}}{4} \text{J} = -5.44 \times 10^{-19} \text{J}$$

53. (b) The right sequence of I.E.₁ of $\text{Li} < \text{B} < \text{Be} < \text{C}$.
54. (c) Photochemical smog does not involve SO_2 .
55. (c) There are four chief minerals present in a Portland cement tricalcium silicate (Ca_3SiO_5), dicalcium silicate (Ca_2SiO_4), tricalcium aluminate ($\text{Ca}_3\text{Al}_2\text{O}_6$) and calcium aluminoferrite ($\text{Ca}_4\text{Al}_n\text{Fe}_{2-n}\text{O}_7$).
56. (a) Ammonia is a weak base and a salt containing its conjugate acid, the ammonium cation, such as NH_4OH functions as a buffer solution when they are present together in a solution.
57. (c) Among these ligands, 'F' is a weak field ligand, makes only high spin complexes which has sp^3d^2 hybridization.
58. (d) Glycosidic linkage is a type of covalent bond that joins either two carbohydrate (sugar) molecule or one carbohydrate to another group. All molecules show such type of linkage.
59. (a) Schotten-Baumann Conditions

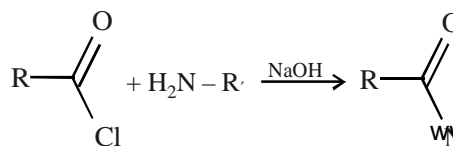

The use of added base to drive the equilibrium in the formation of amides from amines and acid chlorides.

60. (c) Note that in structures 1 and 2, every two adjacent hydrogen atoms are at maximum possible distance from each other (staggered conformation).

61. (b) Bond length decreases with an increase in bond order. Therefore, the order of bond length in these species is $O_2^+ < O_2 > O_2^{2-} < O_2^{2-}$ (bond order - $O_2^+ = 2.5$, $O_2 = 2$, $O_2^- = 1.5$, $O_2^{2-} = 1$)

62. (a) For a given orbital with principal quantum number (n) and azimuthal quantum number (l)
number of radial nodes = (n - 1 - 1)

for 3s orbital: n = 3 and l = 0

therefore, number of radial nodes = 3 - 0 - 1 = 2

for 2p orbital: n = 2 and l = 1

therefore, number of radial nodes = 2 - 1 - 1 = 0

63. (c) $M_1V_1 = M_2V_2$

$$(0.025 \text{ M})(0.050 \text{ L}) = (M_2)(0.025 \text{ L})$$

$$M_2 = 0.05 \text{ M}$$

but, there are 2 H's per H_2SO_4 so $[H_2SO_4] = 0.025 \text{ M}$

64. (a) Given, mass ratio is C:H:O (6:1:24) so, molar ratio will be 6/12:1/1:24/16 = 1:2:3

therefore, HO-(C=O)-OH has molar ratio 1:2:3

65. (b) In bcc structure,

no. of atoms at corner = $1/8 \times 8 = 1$

no. of atom at body centre = 1

therefore, total no of atom per unit cell = 2.

66. (b) PH_5 does not exist because d-orbital of 'P' interacts with s-orbital of H. Bond formed is not stable and not energetically favorable. It depends on size and orientation of interaction.

67. (b) Ionic bonding is non directional, whereas covalent bonding is directional. So, CO_2 is directional.

68. (a) Given ΔH 35.5 kJ mol⁻¹

$$\Delta S = 83.6 \text{ JK}^{-1} \text{ mol}^{-1}$$

$$\therefore \Delta G = \Delta H - T\Delta S$$

For a reaction to be spontaneous, $\Delta G = -ve$

i.e., $\Delta H < T\Delta S$

$$\therefore T > \frac{\Delta H}{\Delta S} = \frac{35.5 \times 10^3 \text{ Jmol}^{-1}}{83.6 \text{ JK}^{-1}}$$

So, the given reaction will be spontaneous at $T > 425 \text{ K}$

69. (c) $\lambda_m = \frac{1000k}{0.1} = \frac{1000 \times 3.75 \times 10^{-4}}{0.1} = 3.75;$

$$\alpha = \frac{\lambda_m}{\lambda_m^\infty} = \frac{3.75}{250} = 1.5 \times 10^{-2};$$

$$K_a = C\alpha^2 = 0.1 \times (1.5 \times 10^{-2})^2 = 2.25 \times 10^{-5}$$

70. (b) $\text{Rate}_1 = k[A]^x[B]^y \dots (1)$

$$\frac{\text{Rate}_1}{4} = k[A]^x[2B]^y \dots (2)$$

or $\text{Rate}_1 = 4k[A]^x[2B]^y$

From (1) and (2) we get

$$\frac{k[A]^x[B]^y}{4} = k[A]^x[2B]^y$$

$$\frac{[B]^y}{4} = [2B]^y$$

$$\text{or } \frac{1}{4} = \left(\frac{2B}{B}\right)^y \Rightarrow \frac{1}{4} = 2^y \text{ or } (2)^{-2} = 2^y$$

$y = -2.$

71. (a) A compound is said to exhibit optical isomerism if it atleast contains one chiral carbon atom, which is an atom bonded to 4 different atoms or groups.

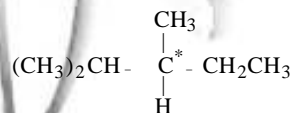

72. (c) Meso compounds are characterized by an internal plane of symmetry that renders them achiral.

73. (a) Control rods slowdown the motion of neutrons and help in controlling the rate of fission. Cadmium is efficient for this purpose.

74. (c) Reducing reagent is needed, as shown in given reaction.

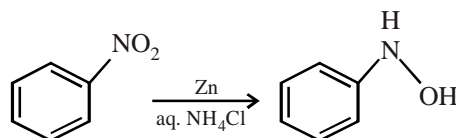

75. (c) $H_2CO_3 \rightleftharpoons H^+ + HCO_3^- \rightleftharpoons H^+ + CO_3^{2-}$
 HCO_3^- can donate and accept H^+ .

76. (c)

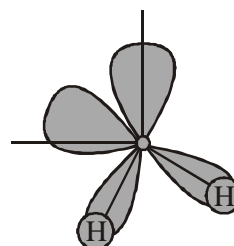
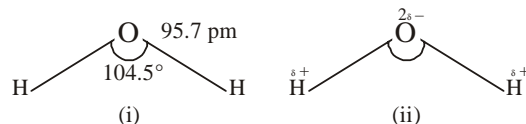

(iii)

77. (c) Because Na is very reactive and cannot be extracted by means of the reduction by C, CO or CO_2 by electrolysis.

78. (d) Rotation of B through 180° within the plane of the paper gives D which is an enantiomer of A, hence A and B are enantiomers

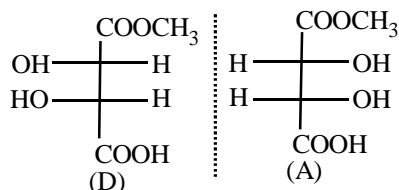
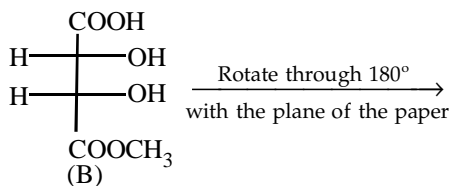

79. (b)
80. (a) Thyroxine is an amine hormone.

PART - III (A) : ENGLISH PROFICIENCY

81. (a) The word **Loquacious (Adjective)** means : talking a lot; talkative. Option (a) is the right synonym while others have different meanings.
82. (c) The word **Meticulous (Adjective)** means : paying careful attention to every detail; fastidious; thorough.
Careless in option (c) is the correct antonymy.
83. (c) 84. (b) 85. (d) 86. (b)
87. (b) China is a big country. In area it is bigger than any other country except Russia. [except means other than, accept means consent, expect means to anticipate and access means entrance].
88. (d) The treasure was hidden off the shore. When something is hidden "off the shore," it just means that it's hidden somewhere near it.
89. (b) Delete 'pair of' before binocular because the word 'binocular' itself suggests a pair.
90. (b) Delete 'all' before 'left'. Here the usage of 'all' is superfluous as 'the teacher as well as his students' itself signifies everyone.

PART - III (B) : LOGICAL REASONING

91. (b)
92. (d) Option (d) will complete the question figure.
93. (a)

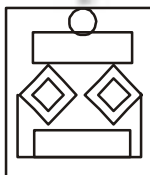

94. (c) All the components of question figure are present in Answer Figure (c)

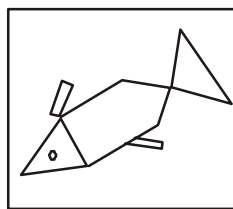

95. (b) In each row, the second figure is obtained from the first figure by adding two mutually perpendicular line segments at the centre and the third figure is obtained from the first figure by adding four circles outside the main figure.
96. (d) In each row, the second figure is obtained by rotating the first figure through 90° CW or 90° ACW and adding a circle to it. Also, the third figure is obtained by adding two circles to the first figure (without rotating the figure).
97. (a) O is the husband of P. M is the son of P.
Therefore, M is the son of O.
98. (a) Wife of Vinod's father means the mother of Vinod.
Only brother of Vinod's mother means maternal uncle of Vinod.
Therefore, Vinod is cousin of Vishal.
99. (a) The pattern is as follows:

$$\begin{array}{ccccccc}
 \text{A} \xrightarrow{+2} & \text{C} \xrightarrow{+2} & \text{E} \xrightarrow{+2} & \text{G} \xrightarrow{+2} & \text{I} \xrightarrow{+2} & \text{K} \\
 \text{G} \xrightarrow{+2} & \text{I} \xrightarrow{+2} & \text{K} \xrightarrow{+2} & \text{M} \xrightarrow{+2} & \text{O} \xrightarrow{+2} & \text{Q} \\
 \text{M} \xrightarrow{+2} & \text{O} \xrightarrow{+2} & \text{Q} \xrightarrow{+2} & \text{S} \xrightarrow{+2} & \text{U} \xrightarrow{+2} & \text{W} \\
 \text{S} \xrightarrow{+2} & \text{U} \xrightarrow{+2} & \text{W} \xrightarrow{+2} & \text{Y} \xrightarrow{+2} & \text{A} \xrightarrow{+2} & \text{C} \\
 \text{Y} \xrightarrow{+2} & \text{A} \xrightarrow{+2} & \text{C} \xrightarrow{+2} & \text{E} \xrightarrow{+2} & \text{G} \xrightarrow{+2} & \text{I}
 \end{array}$$

100. (b) The pattern is as follows :
- $$\begin{array}{ccccccc}
 \text{P} \xrightarrow{+3} & \text{S} \xrightarrow{+3} & \text{V} \xrightarrow{+3} & \text{Y} \xrightarrow{+3} & \text{B} \\
 \text{E} \xrightarrow{+3} & \text{H} \xrightarrow{+3} & \text{K} \xrightarrow{+3} & \text{N} \xrightarrow{+3} & \text{Q} \\
 \text{T} \xrightarrow{+3} & \text{W} \xrightarrow{+3} & \text{Z} \xrightarrow{+3} & \text{C} \xrightarrow{+3} & \text{F} \\
 \text{I} \xrightarrow{+3} & \text{L} \xrightarrow{+3} & \text{O} \xrightarrow{+3} & \text{R} \xrightarrow{+3} & \text{U}
 \end{array}$$
- Therefore, the first term should be
- $$\text{A} \xrightarrow{+3} \text{D} \xrightarrow{+3} \text{G} \xrightarrow{+3} \text{J} \xrightarrow{+3} \text{M}$$
101. (d) The statement implies that politicians win elections by the votes of people. Therefore, neither of the assumptions is implicit in the statement.

102. (d)

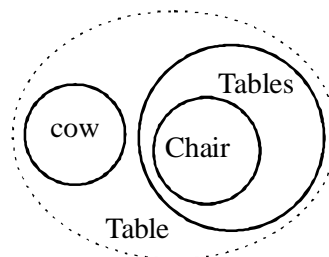

Conc I: True
 Conc II: False
 Conc III: False
 Conc IV: False

or

103. (a) Temple and Church are places of worship. It does not imply that Hindus and Christians use the same place for worship. Church is different temple. Therefore, neither Conclusion I nor II follows.
104. (a) Growth and development of human organism is a continuous process. Some changes take place in human body now and then. Therefore, neither Conclusion I nor II follows.
105. (c)

PART - IV : MATHEMATICS

106. (b) We have $g(-3) = 0$
 $\Rightarrow f(g(-3)) = f(0) = 7(0)^2 + 0 - 8 = -8$
 $\therefore fog(-3) = -8$
 $g(9) = 9^2 + 4 = 85 \Rightarrow f(g(9)) = f(85) = 8(85) + 3 = 683$
 $\therefore fog(9) = 683$
 $f(0) = 7 \cdot 0^2 + 0 - 8 = -8 \Rightarrow g(f(0)) = g(-8) = |-8| = 8$
 $\therefore gof(0) = 8$
 $f(6) = 4(6) + 5 = 29 \Rightarrow g(f(6)) = g(29) = (29)^2 + 4 = 845$
 $\therefore gof(6) = 845$
107. (c) X - X - X - X - X. The four digits 3, 3, 5, 5 can be arranged at (-) places in $\frac{4!}{2!2!} = 6$ ways.

The five digits 2, 2, 8, 8, 8 can be arranged at (X) places in $\frac{5!}{2!3!}$ ways = 10 ways

Total no. of arrangements = $6 \times 10 = 60$ ways

108. (b) $\sum_{k=1}^n (k)(k+1)(k-1) = \sum_{k=1}^n k(k^2-1) = \sum_{k=1}^n (k^3-k)$
 $= \left(\frac{n(n+1)}{2} \right)^2 - \frac{n(n+1)}{2} = \frac{n(n+1)}{2} \left(\frac{n(n+1)}{2} - 1 \right)$
 $= \frac{n^2+n}{2} \left(\frac{n^2+n-2}{2} \right) = \frac{n^4+n^3-2n^2+n^3+n^2-2n}{4}$
 $= \frac{n^4}{4} + \frac{n^3}{2} - \frac{n^2}{4} - \frac{n}{2} \Rightarrow s = -\frac{1}{2}$

109. (c) Let eq. of ellipse be $\frac{x^2}{a^2} + \frac{y^2}{b^2} = 1$, length of semi-latus rectum = $\frac{b^2}{a} = \frac{a^2(1-e^2)}{a} = a(1-e^2)$

$$\text{Given } a(1-e^2) = \frac{1}{3}(2a)$$

$$\Rightarrow 1-e^2 = \frac{2}{3} \Rightarrow e^2 = 1 - \frac{2}{3} = \frac{1}{3} \Rightarrow e = \frac{1}{\sqrt{3}}$$

110. (c) Given quadratic eqn. is $x^2 + px + \frac{3p}{4} = 0$

$$\text{So, } \alpha + \beta = -p, \alpha\beta = \frac{3p}{4}$$

$$\text{Now, given } |\alpha - \beta| = \sqrt{10} \Rightarrow \alpha - \beta = \pm \sqrt{10}$$

$$\Rightarrow (\alpha - \beta)^2 = 10 \Rightarrow \alpha^2 + \beta^2 - 2\alpha\beta = 10$$

$$\Rightarrow (\alpha + \beta)^2 - 4\alpha\beta = 10$$

$$\Rightarrow p^2 - 4 \times \frac{3p}{4} = 10 \Rightarrow p^2 - 3p - 10 = 0$$

$$\Rightarrow p = -2, 5 \Rightarrow p \in \{-2, 5\}$$

111. (d) The given system of lines passes through the point of intersection of the straight lines $2x + y - 3 = 0$ and $3x + 2y - 5 = 0$ [$L_1 + \lambda L_2 = 0$ form], which is (1, 1).

The required line will also pass through this point. Further, the line will be farthest from point (4, -3) if it is in direction perpendicular to line joining (1, 1) and (4, -3).

\therefore The equation of the required line is

$$y - 1 = \frac{-1}{-3-1}(x-1) \Rightarrow 3x - 4y + 1 = 0$$

112. (b) $\frac{n!}{n^n} = \frac{3}{32} \Rightarrow \frac{n!}{n^n} = \frac{8 \times 3}{8 \times 32} = \frac{4!}{4^4}$

$$\therefore n = 4$$

113. (b) $R = (3 + \sqrt{5})^{2n}, G = (3 - \sqrt{5})^{2n}$

Let $[R] + 1 = I$ ($\because [.]$ greatest integer function)

$$\Rightarrow R + G = I (\because 0 < G < 1)$$

$$\Rightarrow (3 + \sqrt{5})^{2n} + (3 - \sqrt{5})^{2n} = I$$

seeing the option put $n = 1$

$I = 28$ is divisible by 4 i.e. 2^{n+1}

114. (c) For $f(x)$ to be defined, we must have

$$-1 \leq \log_2 \left(\frac{1}{2} x^2 \right) \leq 1$$

$$\Rightarrow 2^{-1} \leq \frac{1}{2} x^2 \leq 2^1 \quad [\because \text{the base} = 2 > 1]$$

$$\Rightarrow 1 \leq x^2 \leq 4$$

Now, $1 \leq x^2$

$$\Rightarrow x^2 - 1 \geq 0 \text{ i.e. } (x-1)(x+1) \geq 0$$

$$\Rightarrow x \leq -1 \text{ or } x \geq 1$$

.....(1)

Also, $x^2 \leq 4$

$\Rightarrow x^2 - 4 \leq 0$ i.e. $(x-2)(x+2) \leq 0$

$\Rightarrow -2 \leq x \leq 2$ (3)

Form (2) and (3), we get the domain of

$f = \{(-\infty, -1] \cup [1, \infty)\} \cap [-2, 2]$

$= [-2, -1] \cup [1, 2]$

115. (a) We construct the following table taking assumed mean $a = 55$ (step deviation method).

| Class | X_i | f_i | c.f. | $u_i = \frac{X_i - a}{10}$ | $f_i u_i$ |
|--------|-------|-------|------|----------------------------|-----------|
| 10-20 | 15 | 2 | 2 | -4 | -8 |
| 20-30 | 25 | 3 | 5 | -3 | -9 |
| 30-40 | 35 | 4 | 9 | -2 | -8 |
| 40-50 | 45 | 5 | 14 | -1 | -5 |
| 50-60 | 55 | 6 | 20 | 0 | 0 |
| 60-70 | 65 | 12 | 32 | 1 | 12 |
| 70-80 | 75 | 14 | 46 | 2 | 28 |
| 80-90 | 85 | 10 | 56 | 3 | 30 |
| 90-100 | 95 | 4 | 60 | 4 | 16 |
| Total | | 60 | | | 56 |

The mean $= a + \frac{\sum f_i u_i}{\sum f_i} \times h$
 $= 55 + \frac{56}{60} \times 10 = 55 + \frac{56}{6} = 64.333$

Here $n = 60 \Rightarrow \frac{n}{2} = 30$, therefore, 60-70 is the median class

Using the formula :

$M = l + \frac{\frac{n}{2} - C}{f} \times c = 60 + \frac{30 - 20}{12} \times 10$

$= 60 + \frac{100}{12} = 60 + 8.333 = 68.333$

116. (c) $2e^{iB} = e^{iA} + e^{iC}$
 $\Rightarrow 2\cos B = \cos A + \cos C$ (i)
 & $2\sin B = \sin A + \sin C$ (ii)

Squaring and adding we get

$\cos(A - C) = 1 \Rightarrow A - C = 0$

$\therefore A = C$, From (i) and (ii) $\cos B = \cos A$ and $\sin B = \sin A$

So, $A = B \Rightarrow A = B = C$

117. (c) $d = h \cot 30^\circ - h \cot 60^\circ$ and time = 3 min.

$\therefore \text{Speed} = \frac{h(\cot 30^\circ - \cot 60^\circ)}{3}$ per minute

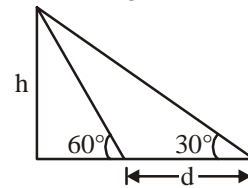

It will travel distance $h \cot 60^\circ$ in

$\frac{h \cot 60^\circ \times 3}{h(\cot 30^\circ - \cot 60^\circ)} = 1.5$ minute

118. (c) Clearly, the total distance described

$= 120 + 2 \left[120 \times \frac{4}{5} + 120 \times \frac{4}{5} \times \frac{4}{5} + 120 \times \frac{4}{5} \times \frac{4}{5} \times \frac{4}{5} + \dots \text{to } \infty \right]$

Except in the first fall the same ball will travel twice in each step the same distance one upward and second downward travel.

\therefore Distance travelled

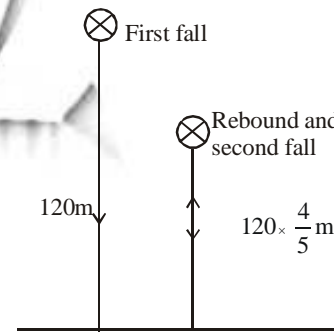

$= 120 + 2 \times 120 \left[\frac{4}{5} + \left(\frac{4}{5} \right)^2 + \dots \text{to } \infty \right]$

$= 120 + 240 \left[\frac{4}{5} \right] = 120 + 240 \times 4 = 1080\text{m}$

119. (c) Since the equilateral triangle is inscribed in the circle with centre at the origin, centroid lies on the origin.

So, $\frac{AO}{OD} = \frac{2}{1}$

$\Rightarrow OD = \frac{1}{2}AO = \frac{a}{2}$

So, other vertices of triangle have coordinates,

$\left(-\frac{a}{2}, \frac{\sqrt{3}a}{2} \right)$ and $\left[-\frac{a}{2}, -\frac{\sqrt{3}}{2}a \right]$

$\left(-\frac{a}{2}, \frac{\sqrt{3}}{2}a \right)$

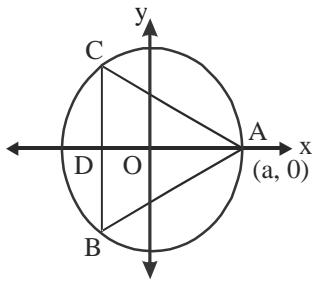

$$\left(-\frac{a}{2}, \frac{\sqrt{3}}{2}a\right)$$

∴ Equation of line BC is:

$$x = -\frac{a}{2}$$

$$\Rightarrow 2x + a = 0$$

120. (a) we have, $f(x) = |x - |x - x^2|| = |x - |x(1 - x)||$
 $= |x - |x||1 - x||$

∴ Continuity is to be checked at $x = 0$ and $x = 1$. At $x = 0$

$$\begin{aligned} \text{LHL} &= \lim_{h \rightarrow 0} f(0 - h) = \lim_{h \rightarrow 0} |h - |h - |1 - h|| \\ &= \lim_{h \rightarrow 0} |h - h| = 0 \end{aligned}$$

$$\text{RHL} = \lim_{h \rightarrow 0} f(0 + h) = \lim_{h \rightarrow 0} |h - |h||1 - h|| = \lim_{h \rightarrow 0} |h - h(1 - h)| = 0$$

and $f(0) = 0$

Since $\text{LHL} = \text{RHL} = f(0)$, ∴ $f(x)$ is continuous at $x = 0$.

At $x = 1$

$$\begin{aligned} \text{LHL} &= \lim_{h \rightarrow 0} f(1 - h) = \lim_{h \rightarrow 0} |1 - h - |1 - h||1 - (1 - h)|| \\ &= \lim_{h \rightarrow 0} |1 - h - h| = 1 \end{aligned}$$

$$\text{Similarly RHL} = \lim_{h \rightarrow 0} f(1 + h) = 1$$

$$\text{and } f(1) = |1 - |1||1 - 1|| = 1$$

∴ $f(x)$ is continuous at $x = 1$

Hence $f(x)$ is continuous for all $x \in [-1, 1]$

121. (d) Let $P(n) : \frac{4^n}{n+1} < \frac{(2n)!}{(n!)^2}$

For $n = 2$,

$$P(2) : \frac{4^2}{2+1} < \frac{4!}{(2!)^2} \Rightarrow \frac{16}{3} < \frac{24}{4}$$

which is true.

Let for $n = m \geq 2$, $P(m)$ is true.

$$\text{i.e. } \frac{4^m}{m+1} < \frac{(2m)!}{(m!)^2}$$

$$\text{Now, } \frac{4^{m+1}}{m+2} = \frac{4^m}{m+1} \cdot \frac{4(m+1)}{m+2}$$

$$< \frac{(2m)!}{(m!)^2} \cdot \frac{4(m+1)}{(m+2)}$$

$$= \frac{(2m)!(2m+1)(2m+2)4(m+1)(m+1)^2}{(2m+1)(2m+2)(m!)^2(m+1)^2(m+2)}$$

$$= \frac{[2(m+1)]!}{[(m+1)!]^2} \cdot \frac{2(m+1)^2}{(2m+1)(m+2)}$$

$$< \frac{[2(m+1)]!}{[(m+1)!]^2}$$

Hence, for $n \geq 2$, $P(n)$ is true.

122. (b) $\Delta = \begin{vmatrix} -a & 1 & 1 \\ 1 & -b & 1 \\ 1 & 1 & -c \end{vmatrix} = 0$ for non-zero solution

$$\Rightarrow abc - a - b - c - 2 = 0$$

$$\Rightarrow abc = a + b + c + 2$$

$$\text{Now, } \frac{1}{1+a} + \frac{1}{1+b} + \frac{1}{1+c}$$

$$= \frac{3 + 2(a+b+c) + (ab+bc+ac)}{1 + (a+b+c) + (ab+bc+ac) + abc}$$

$$= \frac{3 + 2(a+b+c) + (ab+bc+ac)}{1 + 2(a+b+c) + 2(ab+bc+ac)} = 1$$

123. (b) A function $f(x)$ is said to be increasing function in $[a, b]$ if $f'(x) > 0$ in $[a, b]$.

$$\text{Given } f(x) = x^x \quad \dots (i)$$

Differentiate equation (i)

$$f'(x) = x^x(1 + \log x)$$

$$\text{Put } f'(x) = 0$$

$$0 = x^x(1 + \log x)$$

$$\Rightarrow x = 0, \log x = -1 \Rightarrow x = e^{-1}$$

$$\Rightarrow x = \frac{1}{e}, 0$$

$$\text{Now, in } \left[0, \frac{1}{e}\right], f'(x) > 0$$

$$\therefore f(x) \text{ is increasing in interval } \left[0, \frac{1}{e}\right]$$

124. (d) Let $y = \frac{x}{x^2 - 5x + 9}$

$$\Rightarrow x^2y - (5y + 1)x + 9y = 0$$

for real x, Discriminant = $b^2 - 4ac \geq 0$

$$(5y + 1)^2 - 36y^2 \geq 0$$

$$\Rightarrow (5y + 1 - 6y)(5y + 1 + 6y) \geq 0$$

$$\Rightarrow (-y + 1)(11y + 1) \geq 0$$

$$\Rightarrow (y - 1)(11y + 1) \leq 0$$

$$\Rightarrow y \in \left[\frac{-1}{11}, 1 \right]$$

125. (d) Putting $x = \frac{1}{y}$, we get

$$L = \lim_{y \rightarrow 0} \left(\frac{a_1^y + a_2^y + \dots + a_n^y}{n} \right)^{n/y} \quad (\because x \rightarrow \infty \Rightarrow y \rightarrow 0)$$

$$\therefore \log_e L = \lim_{y \rightarrow 0} \frac{n}{y} \cdot \log_e \frac{1}{n} (a_1^y + a_2^y + \dots + a_n^y) \left(\frac{0}{0} \right)$$

$$= n \lim_{y \rightarrow 0} \frac{\left(\frac{a_1^y \log a_1 + a_2^y \log a_2 + \dots + a_n^y \log a_n}{a_1^y + a_2^y + \dots + a_n^y} \right)}{1}$$

[using L'Hopital rule]

$$= n \cdot \frac{\log(a_1 a_2 \dots a_n)}{n}$$

$$\therefore \log L = \log(a_1 \cdot a_2 \cdot \dots \cdot a_n) \Rightarrow L = a_1 \cdot a_2 \cdot a_3 \cdot \dots \cdot a_n$$

126. (d) We have $\cot^{-1} 7 + \cot^{-1} 8 + \cot^{-1} 18$

$$\because xy = \frac{1}{7} \cdot \frac{1}{8} < 1$$

$$\therefore \tan^{-1} \frac{1}{7} + \tan^{-1} \frac{1}{8} + \tan^{-1} \frac{1}{18}$$

$$= \tan^{-1} \left(\frac{\frac{1}{7} + \frac{1}{8}}{1 - \frac{1}{7} \times \frac{1}{8}} \right) + \tan^{-1} \frac{1}{18} = \tan^{-1} \frac{15}{55} + \tan^{-1} \frac{1}{18}$$

$$\text{also; } \frac{3}{11} \times \frac{1}{18} < 1$$

$$\tan^{-1} \frac{3}{11} + \tan^{-1} \frac{1}{18} = \tan^{-1} \left(\frac{\frac{3}{11} + \frac{1}{18}}{1 - \frac{3}{11} \times \frac{1}{18}} \right)$$

$$= \tan^{-1} \frac{65}{195} = \tan^{-1} \frac{1}{3} = \cot^{-1} 3$$

127. (a) Let, $I = \int \frac{\cos x - 1}{\sin x + 1} e^x dx$

$$= \int \left[\frac{\cos x}{\sin x + 1} - \frac{1}{\sin x + 1} \right] e^x dx$$

$$= \int \frac{\cos x}{1 + \sin x} e^x dx - \int \frac{1}{\sin x + 1} e^x dx$$

$$= \frac{e^x \cdot \cos x}{1 + \sin x} - \int \frac{-(1 + \sin x) \sin x - \cos^2 x}{(1 + \sin x)^2} e^x dx$$

$$- \int \frac{e^x}{\sin x + 1} dx$$

$$= \frac{e^x \cos x}{1 + \sin x} + \int \frac{e^x}{1 + \sin x} dx - \int \frac{e^x dx}{1 + \sin x}$$

$$= \frac{e^x \cos x}{1 + \sin x} + C$$

[Using $\int e^x \{f(x) + f'(x)\} dx = e^x f(x) + C$]

128. (b) $P(E) = P(2 \text{ or } 3 \text{ or } 5 \text{ or } 7)$

$$= 0.23 + 0.12 + 0.20 + 0.07 = 0.62$$

$$P(F) = P(1 \text{ or } 2 \text{ or } 3) = 0.15 + 0.23 + 0.12 = 0.50$$

$$P(E \cap F) = P(2 \text{ or } 3) = 0.23 + 0.12 = 0.35$$

$$\therefore P(E \cup F) = P(E) + P(F) - P(E \cap F)$$

$$= 0.62 + 0.50 - 0.35 = 0.77$$

129. (c) We have $\cos x + \cos 2x + \cos 3x = 0$

$$\text{or } (\cos 3x + \cos x) + \cos 2x = 0$$

$$\text{or } 2 \cos 2x \cdot \cos x + \cos 2x = 0$$

$$\text{or } \cos 2x(2 \cos x + 1) = 0$$

We have, either $\cos 2x = 0$ or $2 \cos x + 1 = 0$

$$\text{If } \cos 2x = 0, \text{ then } 2x = (2m + 1) \frac{\pi}{2}$$

$$\text{or } x = (2m + 1) \frac{\pi}{4}, m \in I$$

$$\text{If } 2 \cos x + 1 = 0, \text{ then } \cos x = -\frac{1}{2} = \cos \frac{2\pi}{3}$$

$$\Rightarrow x = 2n\pi \pm \frac{2\pi}{3}, n \in I$$

Hence the required general solution are

$$x = (2m + 1) \frac{\pi}{4} \text{ and } x = 2n\pi \pm \frac{2\pi}{3}, m, n \in I$$

130. (b) $y = |\cos x - \sin x|$

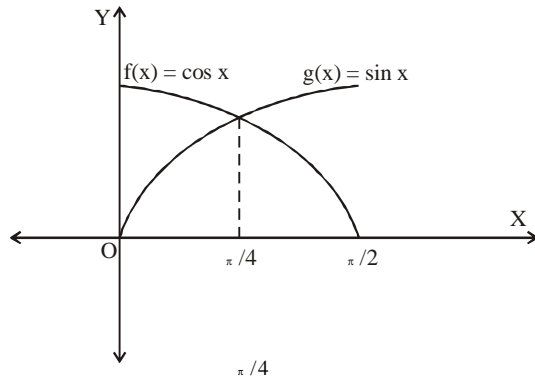

Required area = $2 \int_0^{\pi/4} (\cos x - \sin x) dx$

= $2 [\sin x + \cos x]_0^{\pi/4} = 2 \left[\frac{2}{\sqrt{2}} - 1 \right] = (2\sqrt{2} - 2)$ sq. units

131. (a) We have,

$Lf'(0) = \lim_{h \rightarrow 0} \frac{f(0-h) - f(0)}{-h} = \lim_{h \rightarrow 0} \frac{-h \log \cosh}{-h \log(1+h^2)}$

= $\lim_{h \rightarrow 0} \frac{\log \cosh}{\log(1+h^2)}$ ($\frac{0}{0}$ form)

= $\lim_{h \rightarrow 0} \frac{-\tan h}{2h/(1+h^2)} = -1/2$

$Rf'(0) = \lim_{h \rightarrow 0} \frac{f(0+h) - f(0)}{h} = \lim_{h \rightarrow 0} \frac{h \log \cosh}{h \log(1+h^2)}$

= $\lim_{h \rightarrow 0} \frac{\log \cosh}{\log(1+h^2)}$ ($\frac{0}{0}$ form)

= $\lim_{h \rightarrow 0} \frac{-\tan h}{2h/(1+h^2)} = \frac{-1}{2}$

Since $Lf'(0) = Rf'(0)$, therefore $f(x)$ is differentiable at $x=0$

Since differentiability

= continuity, therefore $f(x)$ is continuous at $x=0$.

132. (b) Given : $x + 2y \geq 2$ (1)

$x + 2y \leq 8$ (2)

and $x, y \geq 0$

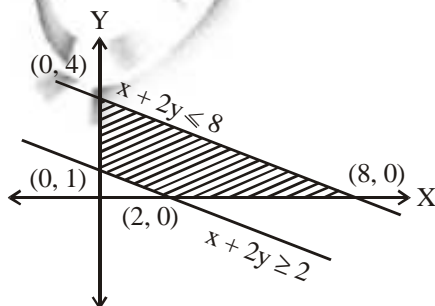

For equation (1)

$\frac{x}{2} + \frac{y}{1} = 1$

and for equation (2)

$\frac{x}{8} + \frac{y}{4} = 1$

Given : $z = 3x + 2y$

At point (2, 0); $z = 3 \times 2 + 0 = 6$

At point (0, 1); $z = 3 \times 0 + 2 \times 1 = 2$

At point (8, 0); $z = 3 \times 8 + 2 \times 0 = 24$

At point (0, 4); $z = 3 \times 0 + 2 \times 4 = 8$

∴ maximum value of z is 24 at point (8, 0).

133. (c) $V = \pi r^2 h = \text{constant}$. If k be the thickness of the sides then that of the top will be $(5/4)k$.

∴ $S = (2\pi rh)k + (\pi r^2) \cdot (5/4)k$

(‘S’ is vol. of material used)

or $S = 2\pi rk \cdot \frac{V}{\pi r^2} + \frac{5}{4} \pi r^2 k = k \left(\frac{2V}{r} + \frac{5}{4} \pi r^2 \right)$

∴ $\frac{dS}{dr} = k \left(-\frac{2V}{r^2} + \frac{5}{2} \pi r \right)$, ∴ $r^3 = 4V/5\pi$

$\frac{d^2S}{dr^2} = k \left(\frac{4V}{r^3} + \frac{5}{2} \pi \right)$, ∴ $\frac{15}{2} k\pi = \text{positive}$

When $r^3 = 4V/5\pi$ or $5\pi r^3 = 4\pi r^2 h$. ∴ $\frac{r}{h} = \frac{4}{5}$.

134. (d) We have

$n(A \cup B \cup C) = n(A) + n(B) + n(C) -$

$n(A \cap B) - n(B \cap C) - n(C \cap A) + n(A \cap B \cap C)$
 $= 10 + 15 + 20 - 8 - 9 - n(C \cap A) + n(A \cap B \cap C)$
 $= 28 - \{n(C \cap A) - n(A \cap B \cap C)\}$ (i)

Since $n(C \cap A) \geq n(A \cap B \cap C)$

We have $n(C \cap A) - n(A \cap B \cap C) \geq 0$ (ii)

From (i) and (ii)

$n(A \cup B \cup C) \leq 28$ (iii)

Now, $n(A \cup B) = n(A) + n(B) - n(A \cap B)$
 $= 10 + 15 - 8 = 17$

and $n(B \cup C) = n(B) + n(C) - n(B \cap C)$
 $= 15 + 20 - 9 = 26$

Since, $n(A \cup B \cup C) \geq n(A \cup C)$ and

$n(A \cup B \cup C) \geq n(B \cup C)$, we have

$n(A \cup B \cup C) \geq 17$ and $n(A \cup B \cup C) \geq 26$

Hence $n(A \cup B \cup C) \geq 26$ (iv)

From (iii) and (iv) we obtain

$26 \leq n(A \cup B \cup C) \leq 28$

Also $n(A \cup B \cup C)$ is a positive integer

∴ $n(A \cup B \cup C) = 26$ or 27 or 28

135. (a) $z = 1 + 2i \Rightarrow |z| = \sqrt{1+4} = \sqrt{5}$

$$\begin{aligned} \therefore f(z) &= \frac{7-z}{1-z^2} = \frac{7-1-2i}{1-(1+2i)^2} \\ &= \frac{6-2i}{1-(1-4+4i)} = \frac{6-2i}{4-4i} = \frac{3-i}{2-2i} \\ \Rightarrow |f(z)| &= \left| \frac{3-i}{2-2i} \right| = \frac{|3-i|}{|2-2i|} = \frac{\sqrt{9+1}}{\sqrt{4+4}} = \frac{\sqrt{5}}{2} = \frac{|z|}{2} \end{aligned}$$

136. (b) Let $f(x) = \cos^{-1} \left[\frac{1 - (\log x)^2}{1 + (\log x)^2} \right]$

Put $\log x = t$ in $f(x)$

$$\therefore f(x) = \cos^{-1} \left[\frac{1-t^2}{1+t^2} \right]$$

Now, put $t = \tan \theta$, we get

$$\begin{aligned} f(x) &= \cos^{-1} \left[\frac{1 - \tan^2 \theta}{1 + \tan^2 \theta} \right] \\ &= \cos^{-1} [\cos 2\theta] = 2\theta = 2 \tan^{-1} t = 2 \tan^{-1} (\log x) \end{aligned}$$

Diff. both side w.r.t 'x', we get

$$f'(x) = 2 \cdot \frac{1}{1+(\log x)^2} \cdot \frac{1}{x}$$

Now,

$$f'(e) = 2 \cdot \frac{1}{1+(\log e)^2} \cdot \frac{1}{e} = \frac{2}{e} \quad (\because \log e = 1)$$

137. (d) Number form by using 1, 2, 3, 4, 5 = $5! = 120$

Number formed by using 0, 1, 2, 4, 5

| | | | | |
|---|---|---|---|---|
| 4 | 4 | 3 | 2 | 1 |
|---|---|---|---|---|

 $= 4.4.3.2.1 = 96$

Total number formed, divisible by 3 (taking numbers without repetition) = 216

Statement 1 is false and statement 2 is true.

138. (c) Any tangent to parabola $y^2 = 8x$ is $y = mx + \frac{2}{m}$... (i)

It touches the circle $x^2 + y^2 - 12x + 4 = 0$, if the length of perpendicular from the centre (6, 0) is equal to radius $\sqrt{32}$.

$$\therefore \frac{6m + \frac{2}{m}}{\sqrt{m^2 + 1}} = \pm \sqrt{32} \Rightarrow \left(3m + \frac{1}{m} \right)^2 = 8(m^2 + 1)$$

$$\Rightarrow (3m^2 + 1)^2 = 8(m^4 + m^2) \Rightarrow m^4 - 2m^2 + 1 = 0 \Rightarrow m = \pm 1$$

Hence, the required tangents are $y = x + 2$ and $y = -x - 2$.

139. (a) $R(s)R(t) = \begin{bmatrix} \cos s & \sin s \\ -\sin s & \cos s \end{bmatrix} \times \begin{bmatrix} \cos t & \sin t \\ -\sin t & \cos t \end{bmatrix}$

$$= \begin{bmatrix} \cos s \cos t - \sin s \sin t & \cos s \sin t + \sin s \cos t \\ -\sin s \cos t - \cos s \sin t & -\sin s \sin t + \cos s \cos t \end{bmatrix}$$

$$= \begin{bmatrix} \cos(s+t) & \sin(s+t) \\ -\sin(s+t) & \cos(s+t) \end{bmatrix} = R(s+t)$$

140. (d) $\int x \log \left(1 + \frac{1}{x} \right) dx$

$$= \log \left(1 + \frac{1}{x} \right) \cdot \frac{x^2}{2} - \int \frac{x}{x+1} \times \left(-\frac{1}{x^2} \right) \times \frac{x^2}{2} dx$$

$$= \frac{x^2}{2} \log \left(\frac{x+1}{x} \right) - \frac{x^2}{2} + \frac{1}{2} \int \frac{x+1-1}{x+1} dx$$

$$= \frac{x^2}{2} \log \left(\frac{x+1}{x} \right) + \frac{1}{2} x - \frac{1}{2} \log(x+1) + c$$

$$= \left(\frac{x^2 - 1}{2} \right) \log(x+1) - \frac{x^2}{2} \log x + \frac{1}{2} x + c$$

141. (c) $\overline{OA} = \vec{a}$, $\overline{OB} = \vec{b}$ & $\overline{OC} = \vec{c}$ are unit vectors and equally inclined to each other at an acute angle θ .

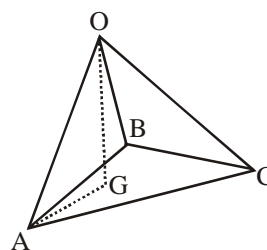

\therefore ABC is an equilateral triangle

$$\begin{aligned} \text{and } AB &= \sqrt{OA^2 + OB^2 - 2OA \cdot OB \cdot \cos \theta} \\ &= \sqrt{2 - 2 \cos \theta} = \sqrt{2} \sqrt{1 - \cos \theta} \end{aligned}$$

\therefore Area of Δ ABC

$$= \frac{\sqrt{3}}{4} AB^2 = \frac{\sqrt{3}}{4} \cdot 2(1 - \cos \theta) = \frac{\sqrt{3}}{2} (1 - \cos \theta)$$

If G is the centroid of the Δ ABC, then

$$OG = \frac{1}{3} |\vec{a} + \vec{b} + \vec{c}|$$

$$= \frac{1}{3} \sqrt{a^2 + b^2 + c^2 + 2\vec{a} \cdot \vec{b} + 2\vec{b} \cdot \vec{c} + 2\vec{c} \cdot \vec{a}}$$

$$= \frac{1}{\sqrt{3}} \sqrt{1 + 2 \cos \theta}$$

$\therefore [\vec{a} \ \vec{b} \ \vec{c}] = \text{Volume of parallelepiped}$

$$= \text{OG} \times 2 \text{ar}(\Delta \text{ABC})$$

$$= 2 \cdot \frac{1}{\sqrt{3}} \sqrt{1 + 2 \cos \theta} \times \frac{\sqrt{3}}{2} (1 - \cos \theta)$$

$$= (1 - \cos \theta) \sqrt{1 + 2 \cos \theta}$$

142. (b) The given product

$$= \frac{1}{2^4} + \frac{2}{8} + \frac{3}{16} + \frac{4}{32} + \dots = 2^s \text{ (say)}$$

$$\text{Now } S = \frac{1}{4} + \frac{2}{8} + \frac{3}{16} + \frac{4}{32} + \dots \quad \dots(1)$$

$$\Rightarrow \frac{1}{2} S = \frac{1}{8} + \frac{2}{16} + \frac{3}{32} + \dots \quad \dots(2)$$

Apply; (1) - (2)

$$\Rightarrow \frac{1}{2} S = \frac{1}{4} + \frac{1}{8} + \frac{1}{16} + \dots$$

$$= \frac{1/4}{1 - 1/2} = \frac{1}{2} \quad \therefore S = 1$$

$$\Rightarrow \text{Product} = 2^1 = 2$$

143. (a) $\frac{{}^n C_r}{{}^{r+3} C_r} = 3! \frac{1}{(r+3)(r+2)} \cdot \frac{{}^n C_r}{(r+1)}$

$$= 3! \frac{1}{(r+3)(r+2)} \cdot \frac{{}^{n-1} C_{r+1}}{(n+1)} \quad [\text{See Formulae}]$$

$$= 3! \frac{1}{(r+3)(n+1)} \cdot \frac{{}^{n-1} C_{r+1}}{r+2}$$

$$= 3! \frac{1}{(r+3)(n+1)} \cdot \frac{{}^{n-2} C_{r+2}}{n+2}$$

$$= \frac{3!}{(n+1)(n+2)} \cdot \frac{{}^{n-2} C_{r+2}}{r+3}$$

$$= \frac{3!}{(n+1)(n+2)(n+3)} \cdot {}^{n-3} C_{r+3}$$

$$\therefore \sum_{r=0}^n (-1)^r \frac{{}^n C_r}{{}^{r+3} C_r} = \frac{6}{(n+1)(n+2)(n+3)} \sum_{r=0}^n (-1)^r {}^{n-3} C_{r+3}$$

$$= \frac{6}{(n+1)(n+2)(n+3)} [{}^{n-3} C_3 - {}^{n-3} C_4 + \dots + (-1)^{n-3} {}^{n-3} C_{n-3}]$$

$$= \frac{6}{(n+1)(n+2)(n+3)} [{}^{n-3} C_0 - {}^{n-3} C_1 + {}^{n-3} C_2]$$

$$[\because {}^{n-3} C_0 - {}^{n-3} C_1 + \dots + (-1)^{n-3} \times {}^{n-3} C_{n-3} = 0]$$

$$= \frac{6}{(n+1)(n+2)(n+3)} \left[1 - n - 3 + \frac{(n+3)(n+2)}{2} \right]$$

$$= \frac{3}{(n+1)(n+2)(n+3)} (n^2 + 3n + 2) = \frac{3}{n+3}$$

Given, $\frac{3}{n+3} = \frac{3}{a+3}$

$$\Rightarrow n = a \Rightarrow a - n = 0$$

144. (c)
$$\begin{vmatrix} p & q-y & r-z \\ p-x & q & r-z \\ p-x & q-y & r \end{vmatrix} = 0$$

Apply $R_1 \rightarrow R_1 - R_3$ and $R_2 \rightarrow R_2 - R_3$, we get

$$\begin{vmatrix} x & 0 & -z \\ 0 & y & -z \\ p-x & q-y & r \end{vmatrix} = 0$$

$$\Rightarrow x[yr + z(q-y)] - z[0 - y(p-x)] = 0$$

[Expansion along first row]

$$\Rightarrow xyr + xzq - xzy + yzp - zyx = 0$$

$$\Rightarrow xyr + zxq + yzp = 2xyz \Rightarrow \frac{p}{x} + \frac{q}{y} + \frac{r}{z} = 2$$

145. (d) Let A_i ($i = 2, 3, 4, 5$) be the event that urn contains 2, 3, 4, 5 white balls and let B be the event that two white balls have been drawn then we have to find $P(A_2/B)$. Since the four events A_2, A_3, A_4 and A_5 are equally

likely we have $P(A_2) = P(A_3) = P(A_4) = P(A_5) = \frac{1}{4}$.

$P(B/A_2)$ is probability of event that the urn contains 2 white balls and both have been drawn.

$$\therefore P(B/A_2) = \frac{{}^2 C_2}{{}^5 C_2} = \frac{1}{10}$$

$$\text{Similarly } P(B/A_3) = \frac{{}^3 C_2}{{}^5 C_2} = \frac{3}{10},$$

$$P(B/A_4) = \frac{{}^4 C_2}{{}^5 C_2} = \frac{3}{5}, \quad P(B/A_5) = \frac{{}^5 C_2}{{}^5 C_2} = 1$$

By Baye's theorem,

$$P(A_5/B) = \frac{P(A_5)P(B/A_5)}{P(A_2)P(B/A_2) + P(A_3)P(B/A_3) + P(A_4)P(B/A_4) + P(A_5)P(B/A_5)}$$

$$= \frac{\frac{1}{4} \cdot 1}{\frac{1}{4} \left[\frac{1}{10} + \frac{3}{10} + \frac{3}{5} + 1 \right]} = \frac{10}{20} = \frac{1}{2}$$

146. (b) As given plane $x + y - z = \frac{1}{2}$ divides the line joining the points A (2, 1, 5) and B (3, 4, 3) at a point C in the ratio k : 1.

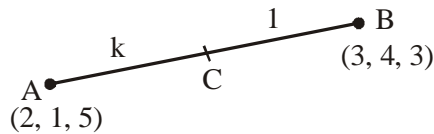

Then coordinates of C

$$\left(\frac{3k+2}{k+1}, \frac{4k+1}{k+1}, \frac{3k+5}{k+1} \right)$$

Point C lies on the plane,

⇒ Coordinates of C must satisfy the equation of plane.

$$\text{So, } \left\{ \frac{3k+2}{k+1} \right\} + \left\{ \frac{4k+1}{k+1} \right\} - \left\{ \frac{3k+5}{k+1} \right\} = \frac{1}{2}$$

$$\Rightarrow 3k+2+4k+1-3k-5 = \frac{1}{2}(k+1)$$

$$\Rightarrow 4k-2 = \frac{1}{2}(k+1)$$

$$\Rightarrow 8k-4 = k+1 \Rightarrow 7k=5$$

$$\Rightarrow k = \frac{5}{7}$$

Ratio is 5 : 7.

147. (c) Let $I = \int_0^{\pi/2} \frac{\sqrt{\sin x}}{\sqrt{\sin x} + \sqrt{\cos x}} dx$... (i)

Then, $I = \int_0^{\pi/2} \frac{\sqrt{\sin(\pi/2-x)}}{\sqrt{\sin(\pi/2-x)} + \sqrt{\cos(\pi/2-x)}} dx$

$$\Rightarrow I = \int_0^{\pi/2} \frac{\sqrt{\cos x}}{\sqrt{\cos x} + \sqrt{\sin x}} dx$$
 ... (ii)

Adding (i) and (ii), we get

$$2I = \int_0^{\pi/2} \frac{\sqrt{\sin x}}{\sqrt{\cos x} + \sqrt{\sin x}} dx + \int_0^{\pi/2} \frac{\sqrt{\cos x}}{\sqrt{\sin x} + \sqrt{\cos x}} dx$$

$$= \int_0^{\pi/2} \frac{\sqrt{\sin x} + \sqrt{\cos x}}{\sqrt{\sin x} + \sqrt{\cos x}} dx = \int_0^{\pi/2} 1 dx = [x]_0^{\pi/2} = \frac{\pi}{2} - 0$$

$$\Rightarrow I = \frac{\pi}{4} \Rightarrow \int_0^{\pi/2} \frac{\sqrt{\sin x}}{\sqrt{\sin x} + \sqrt{\cos x}} dx = \frac{\pi}{4}$$

148. (a) Let the required vector be

$$\vec{v} = x\hat{i} + y\hat{j} + z\hat{k}, \text{ then}$$

$$\vec{v} \cdot (\hat{i} + \hat{j} - 3\hat{k}) = 0 \Rightarrow x + y - 3z = 0$$
 ... (i)

$$\vec{v} \cdot (\hat{i} + 3\hat{j} - 2\hat{k}) = 5 \Rightarrow x + 3y - 2z = 5$$
 ..(ii)

$$\text{and } \vec{v} \cdot (2\hat{i} + \hat{j} + 4\hat{k}) = 8 \Rightarrow 2x + y + 4z = 8$$
 ... (iii)

Subtracting (ii) from (i), we have

$$-2y - z = -5 \Rightarrow 2y + z = 5$$
 ..(iv)

Multiply (ii) by 2 and subtracting (iii) from it, we obtain

$$5y - 8z = 2$$
 ... (v)

Multiply (iv) by 8 and adding (v) to it, we have

$$21y = 42 \Rightarrow y = 2$$
 ... (v)

Substituting $y = 2$ in (iv), we get

$$2 \times 2 + z = 5 \Rightarrow z = 5 - 4 = 1$$

Substituting these values in (i), we get

$$x + 2 - 3 = 0 \Rightarrow x = 3 - 2 = 1$$

Hence, the required vector is

$$\vec{v} = x\hat{i} + y\hat{j} + z\hat{k} = \hat{i} + 2\hat{j} + \hat{k}$$

149. (c) Equation of lines are $\frac{x}{a} - \frac{y}{b} = 1$ and $\frac{x}{b} - \frac{y}{a} = 1$

$$\Rightarrow m_1 = \frac{b}{a} \text{ and } m_2 = \frac{a}{b}$$

$$\text{Therefore } \theta = \tan^{-1} \frac{\frac{b}{a} - \frac{a}{b}}{1 + \frac{b}{a} \cdot \frac{a}{b}} = \tan^{-1} \frac{b^2 - a^2}{2ab}$$

150. (d) Given points are A(k, 1, -1), B(2k, 0, 2) and C(2+2k, k, 1)

Let r_1 = length of line

$$AB = \sqrt{(2k-k)^2 + (0-1)^2 + (2+1)^2} = \sqrt{k^2 + 10}$$

$$\text{and } r_2 = \text{length of line } BC = \sqrt{(2)^2 + k^2 + (-1)^2}$$

$$= \sqrt{k^2 + 5}$$

Now, let l_1, m_1, n_1 be direction-cosines of line AB

and l_2, m_2, n_2 be the direction cosines of BC.

Since AB is perpendicular to BC

$$\therefore l_1 l_2 + m_1 m_2 + n_1 n_2 = 0$$

$$\text{Now, } l_1 = \frac{k}{\sqrt{k^2 + 10}}, m_1 = \frac{-1}{\sqrt{k^2 + 10}},$$

$$n_1 = \frac{3}{\sqrt{k^2 + 10}}$$

$$\text{and } l_2 = \frac{2}{\sqrt{k^2 + 5}}, m_2 = \frac{k}{\sqrt{k^2 + 5}}, n_2 = \frac{-1}{\sqrt{k^2 + 5}}$$

$$\text{So, } l_1 l_2 + m_1 m_2 + n_1 n_2 = 0$$

$$\Rightarrow \frac{2k}{\sqrt{k^2 + 10}\sqrt{k^2 + 5}} - \frac{k}{\sqrt{k^2 + 10}\sqrt{k^2 + 5}} - \frac{3}{\sqrt{k^2 + 10}\sqrt{k^2 + 5}} = 0$$

$$\Rightarrow 2k - k - 3 = 0$$

$$\Rightarrow k = 3$$

For $k = 3$, AB is perpendicular to BC.