

--	--	--	--	--	--	--	--	--	--

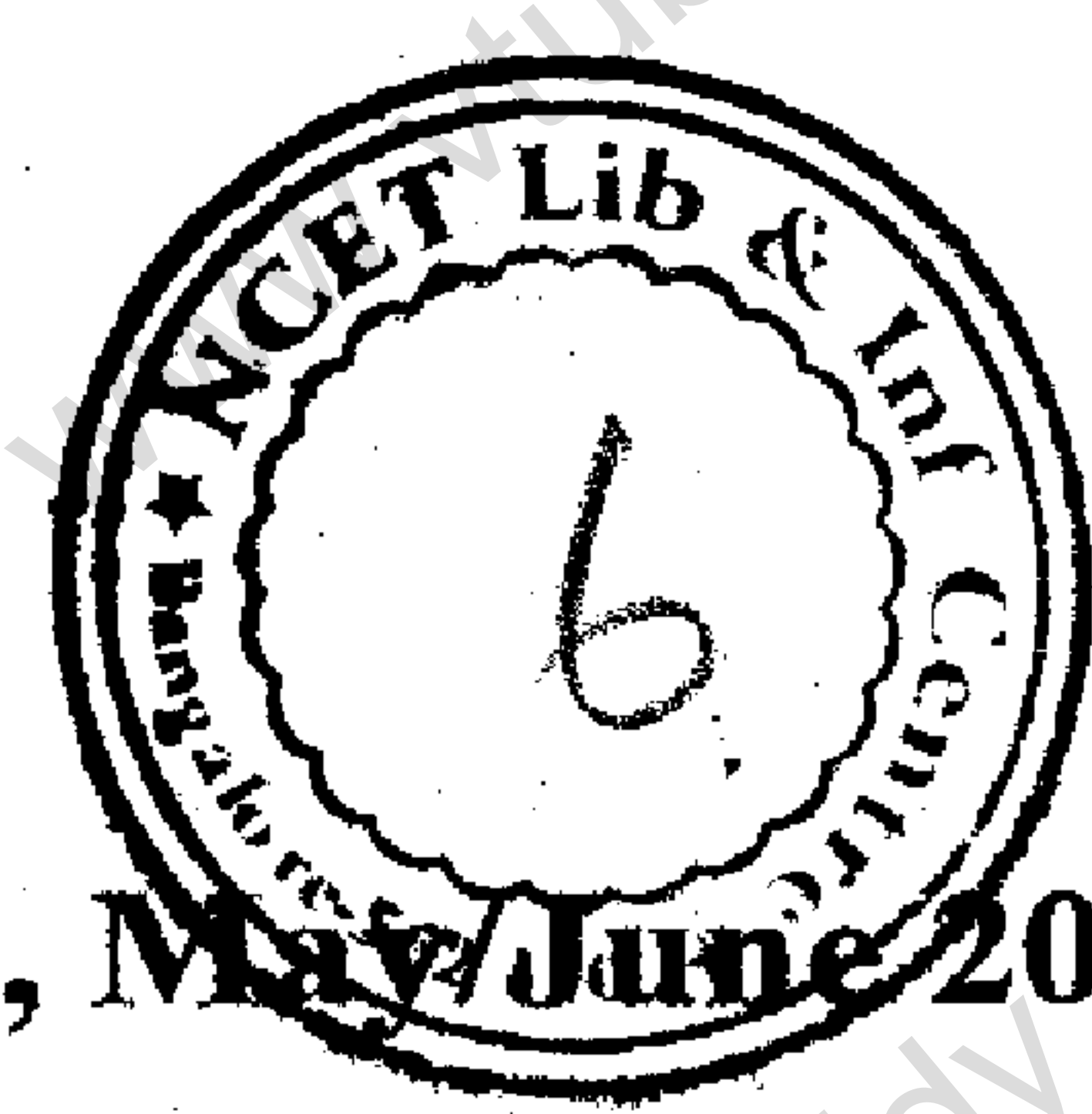

**Third Semester B.E. Degree Examination, May/June 2010**  
**Electronic Circuits**

Time: 3 hrs.

Max. Marks:100

**Note: Answer any FIVE full questions, selecting at least TWO questions from each part.**

**PART - A**

- 1 a. Explain positive clipper and negative clipper, with necessary diagrams. (08 Marks)
- b. For the circuit shown in, Fig. Q1(b) :
  - i) Sketch the output voltage waveform
  - ii) What is the maximum positive output voltage?
  - iii) What is the maximum negative output voltage? (06 Marks)

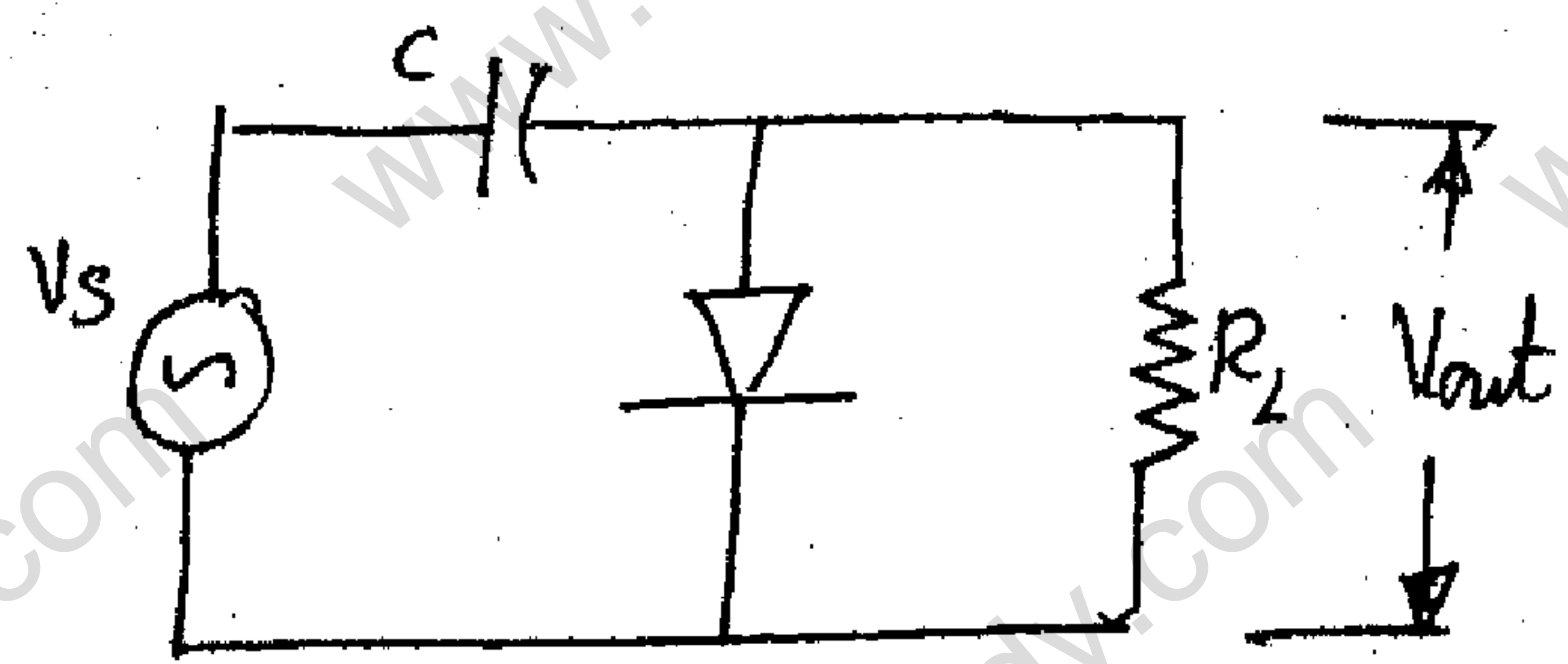
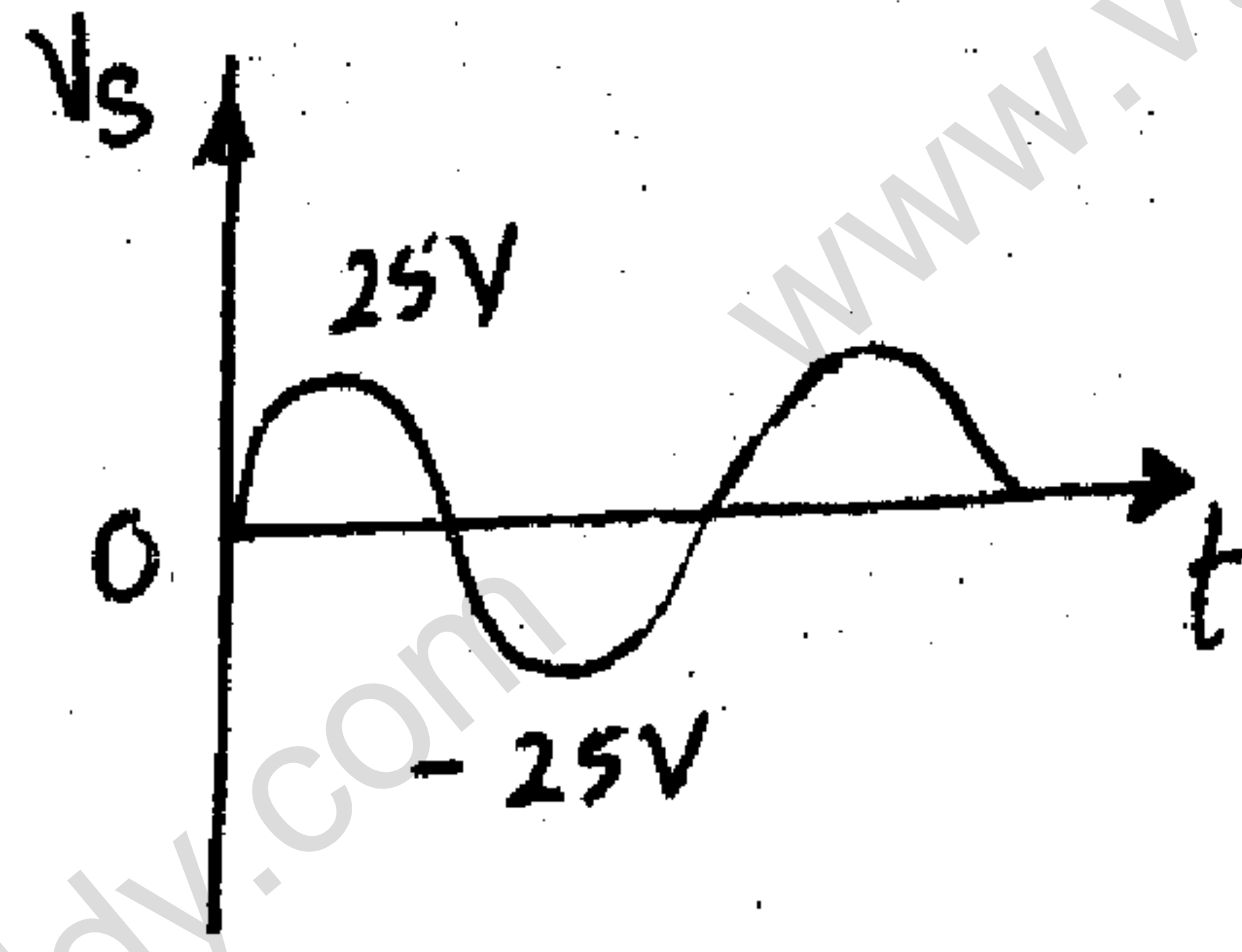

Fig. Q1(b)

- c. Explain SCHOTTKY DIODE construction and its application. (06 Marks)
- 2 a. Explain with a neat circuit diagram, voltage divider bias amplifier by mentioning the importance of bypass capacitor. (06 Marks)
  - b. Obtain the graphical determination of AC emitter resistance of diode. (06 Marks)
  - c. Draw the DC and AC equivalent circuits of voltage divider bias amplifier shown in Fig. Q2(c). (08 Marks)

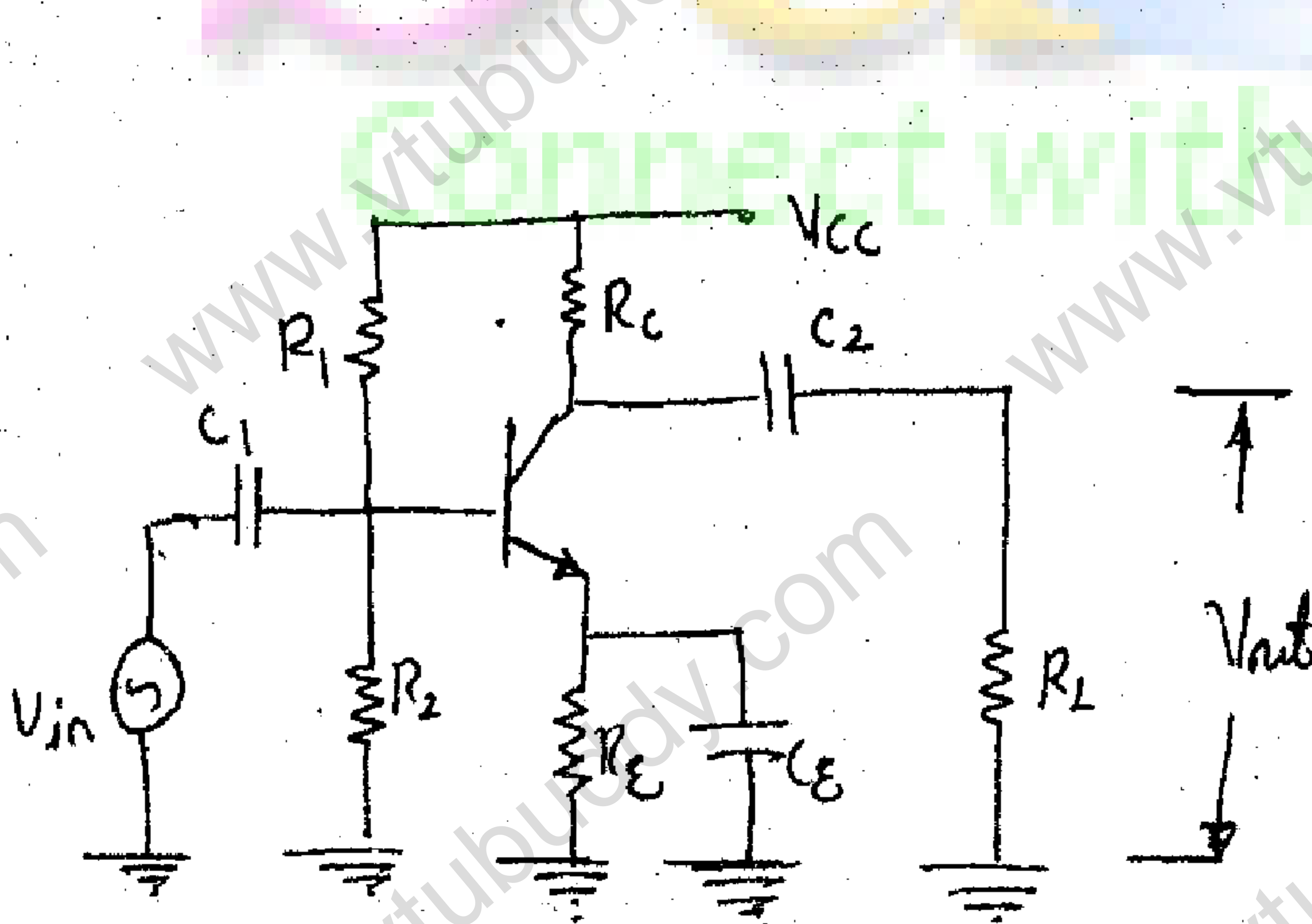

Fig. Q2(c)

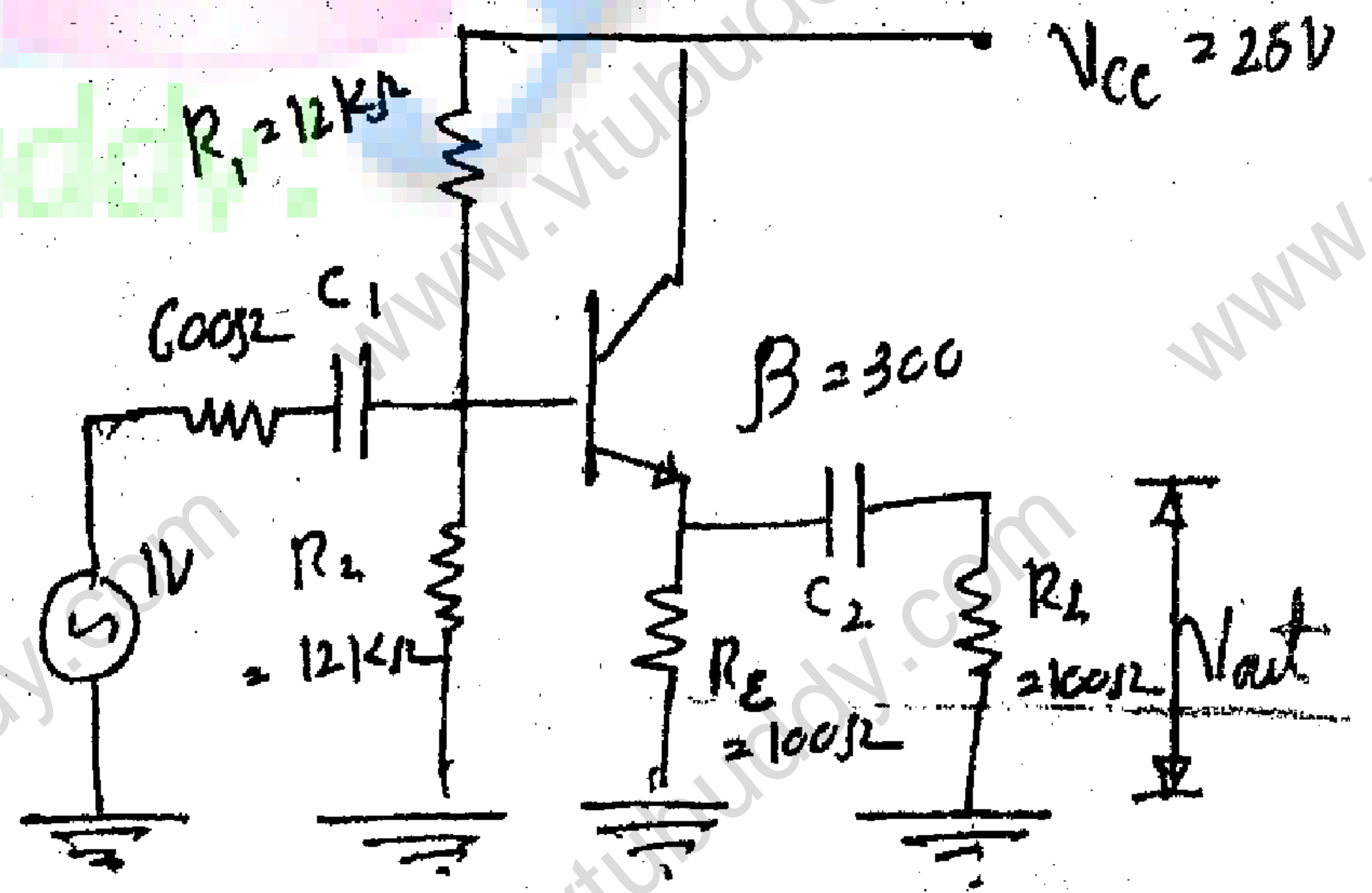

Fig. Q3(c)

- 3 a. Obtain the expression for voltage gain of single stage CE voltage-divider bias amplifier using  $\pi$ -model. (08 Marks)
  - b. Discuss trouble shooting of DC and AC circuits in voltage amplifier. (06 Marks)
  - c. For the circuit shown in, Fig. Q3(c), calculate the voltage of output impedance. (06 Marks)
- 4 a. Explain power gain interms of voltage and current gain in power amplifier. (06 Marks)
  - b. Show that the maximum efficiency of transformer coupled class A power amplifier is 50%. (08 Marks)
  - c. In a class C power amplifier  $V_{CC} = 30\text{ V}$ ;  $R_L = 10\text{ k}\Omega$  current drain  $I_{dc} = 0.4\text{ mA}$  peak-to-peak output voltage  $V_{out(p-p)} = 30\text{ V}$ . Calculate i) DC input power ii) AC input power iii) Efficiency. (06 Marks)

Important Note : 1. On completing your answers, compulsorily draw diagonal cross lines on the remaining blank pages. 2. Any revealing of identification, appeal to evaluator and/or equations written eg, 42+8 = 50, will be treated as malpractice.

**PART – B**

- 5 a. Explain the principle of operation and structure of n-channel depletion mode MOSFET, with a neat sketch. (06 Marks)
- b. Discuss CMOS inverter with a neat circuit diagram, along with the transfer characteristics. (06 Marks)
- c. Obtain the equation for voltage gain of common-source D-MOSFET amplifier. (08 Marks)
- 6 a. Explain the frequency response of a typical AC amplifier, mentioning the importance of cut-off frequency. (08 Marks)
- b. Obtain the formula for decibel power gain and decibel voltage gain. (04 Marks)
- c. For the circuit shown in Fig. Q6(c). Calculate :  
 i) The feedback fraction ii) The ideal closed loop voltage gain iii) The exact closed loop voltage gain iv) The percentage error between ideal and exact values of the closed loop voltage gain. Assume the open loop voltage gain of op. amp as  $10^5$ . (08 Marks)

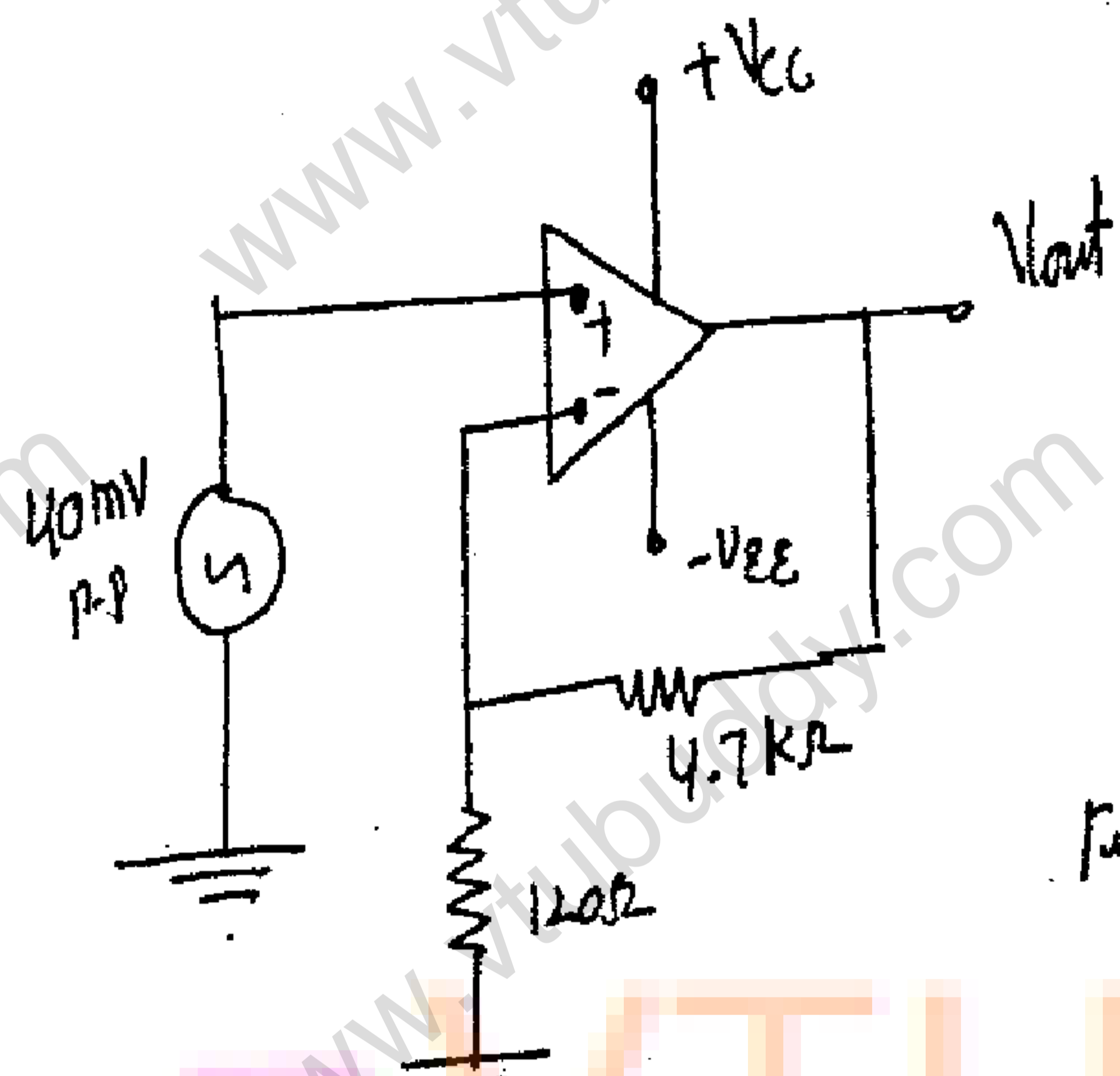

Fig. Q6(c)

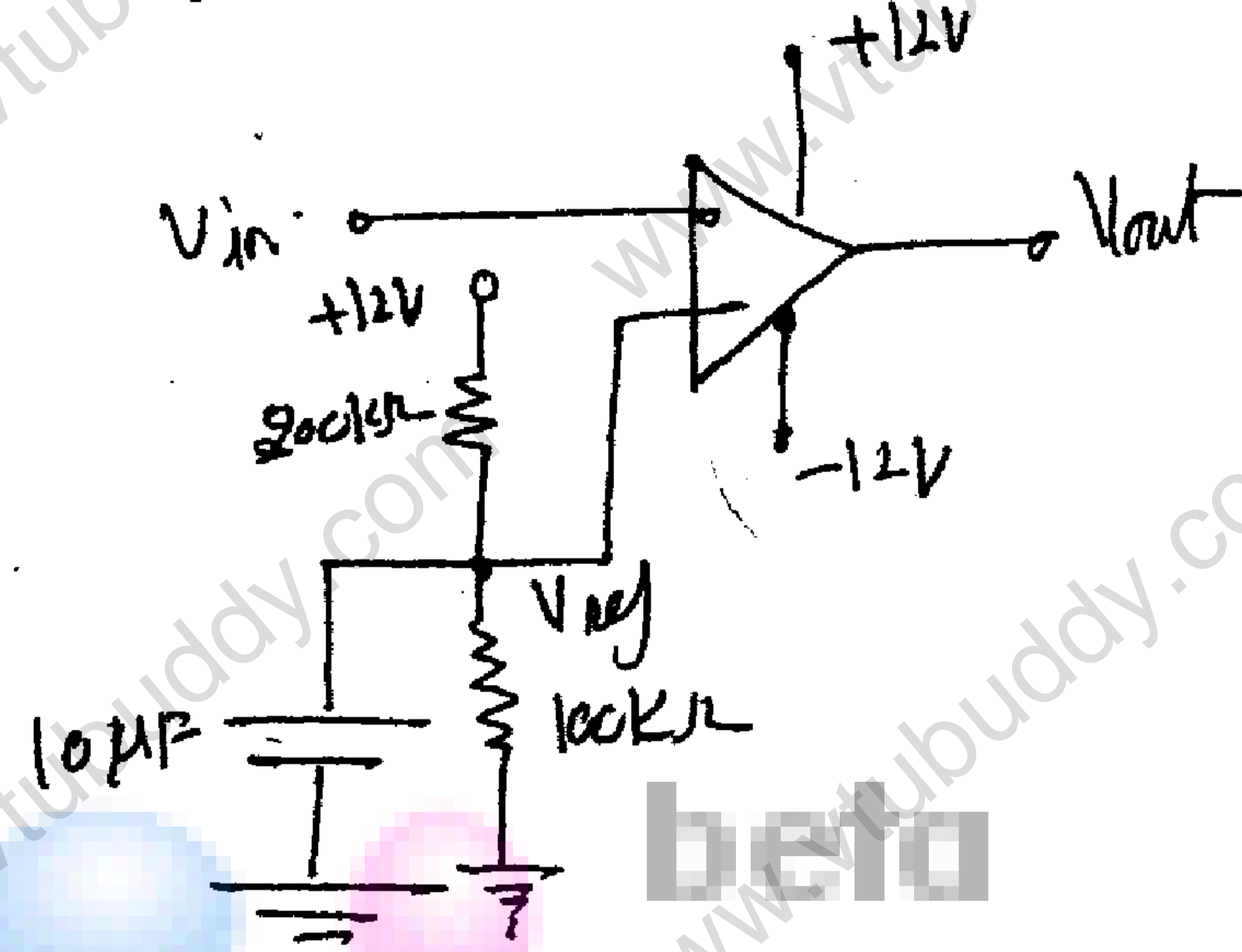

Fig. Q7(b)

- 7 a. Explain the functional block diagram, of 555 timers. (08 Marks)
- b. The input voltage to the circuit shown in, Fig. Q7(b) is a sine wave of peak value 8V.  
 i) Calculate the trip point or threshold ii) Calculate the cut-off frequency of the bypass circuit iii) Sketch the output waveform and determine its duty circle. (08 Marks)
- c. Explain how Schmitt trigger can be used to convert a periodic sine wave to a rectangular wave. (04 Marks)
- 8 a. Explain the various characteristics on which a power supply depends, with respect to quality and suitability : (04 Marks)
- b. Calculate the output voltage for the circuit shown below in the Fig Q8(b) : (08 Marks)

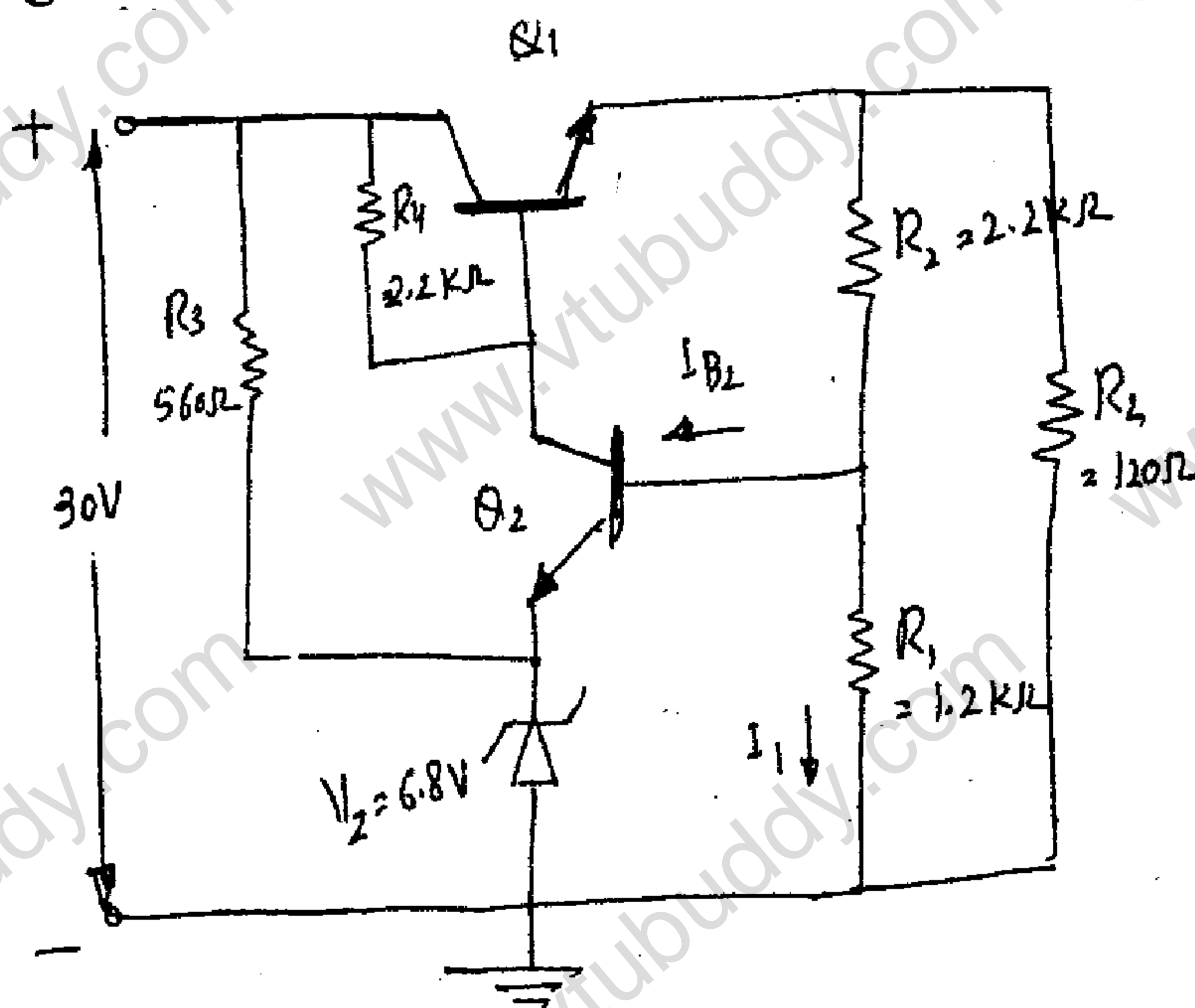

Fig. Q8(b)

- c. Explain with a circuit diagram, unregulated DC to DC converter using power BJTs. (08 Marks)

\*\*\*\*\*