

IRDA SMD & BGA Rework Station T862

User Manual



Puhui Technology (Taian). CO., LTD.

<http://www.puhuit.com>

CONTENT

1. Features.....	2
2. Technical Parameters.....	2
3. List of content.....	2
4. Description of the main parts.....	3
(1) Main body.....	3
(2) Front panel.....	4
(3) Back panel.....	4
(4) Focusing support.....	5
5. Installation.....	6
(1) Install the guide rod.....	4
(2) Install the locating ring.....	5
(3) Complete Assembly.....	5
(4) Connecting wire of the lamp body	7
6. Operating instructions.....	7
(1) Starting.....	7
(2) Unsoldering operation.....	8
(3) Soldering operation.....	8
(4) Using the soldering iron.....	9
7. Caution!	9
8. Warranty.....	10

Features

1. Use of infrared welding technology which is developed independently.
2. Use of an infrared heat lamp. Heat is easy to pierce and distribute evenly, which overcome disadvantage (burn out elements) of traditional welding machines.
3. Easy operation. You just need one-day training and you can operate it skillfully.
4. No need for unsolder tools. IRDA Welder T-862 can unsolder all the elements between 05 and 20mm.
5. This machine has 650W hot-melt system. Its preheating area is 80x120mm.
6. Infrared heating without heated air flowing. No impact on circumjacent small elements. It is suitable for all of the elements, especially Micro BGA elements.

Technical parameters

Working voltage	AC220/110v 50/60Hz
Output power	600W
Temperature	100 °C – 350 °C

List of content

Welder base	1
Guide rod	1
Locating ring	1
Lamp assy	1
Circuit Board(PCB) support	1
Power Cable	1
Soldering iron	1
Soldering iron support	1
User manual	1

Description of the main parts

1. Main body

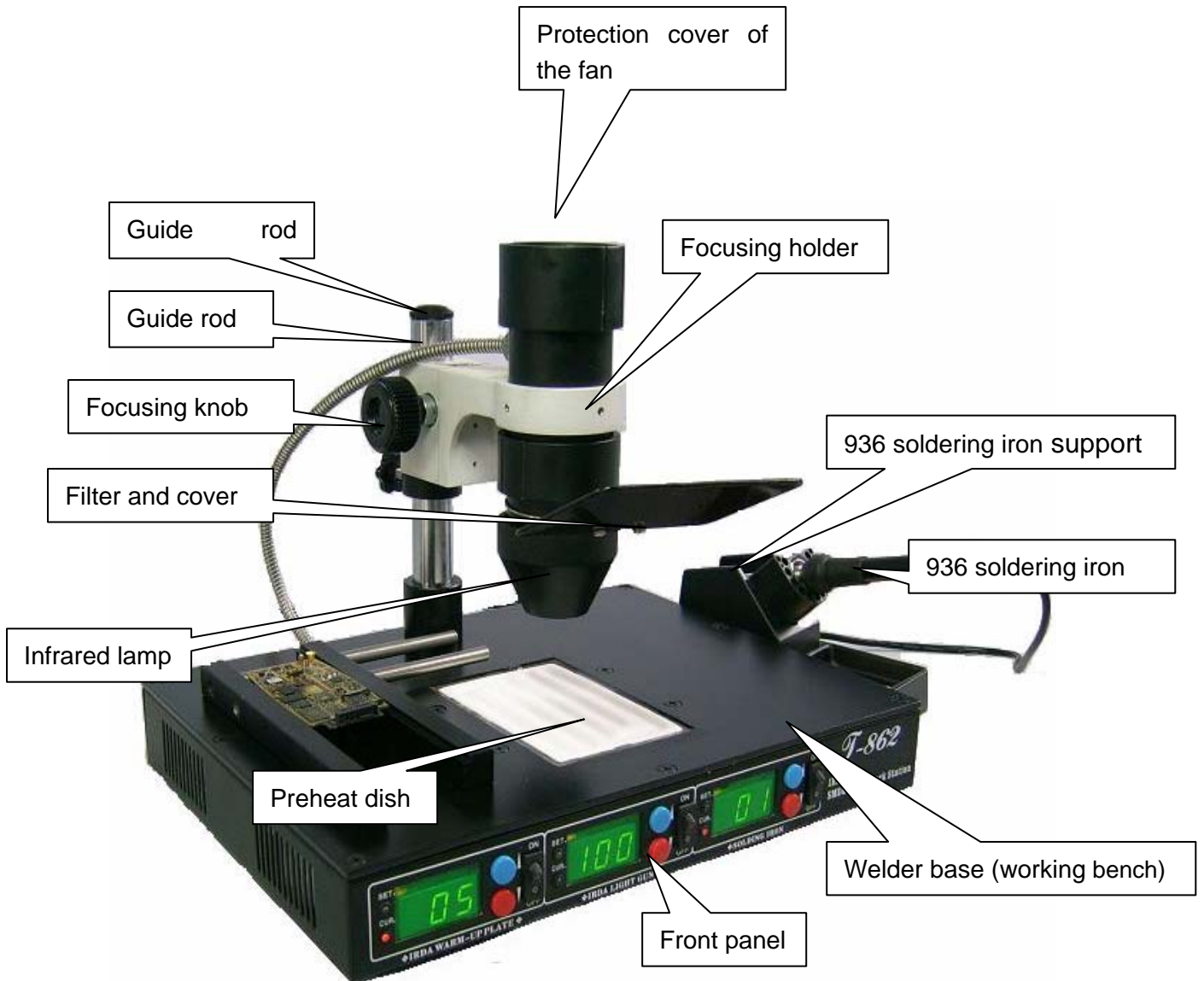

2. Front panel

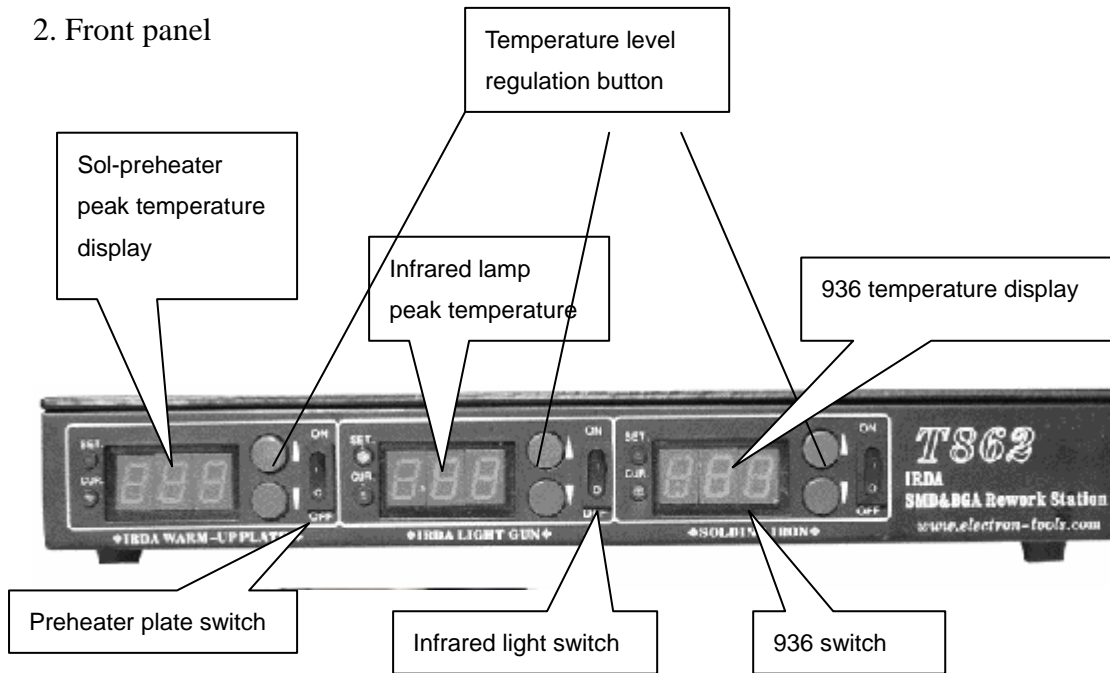

3. Back panel

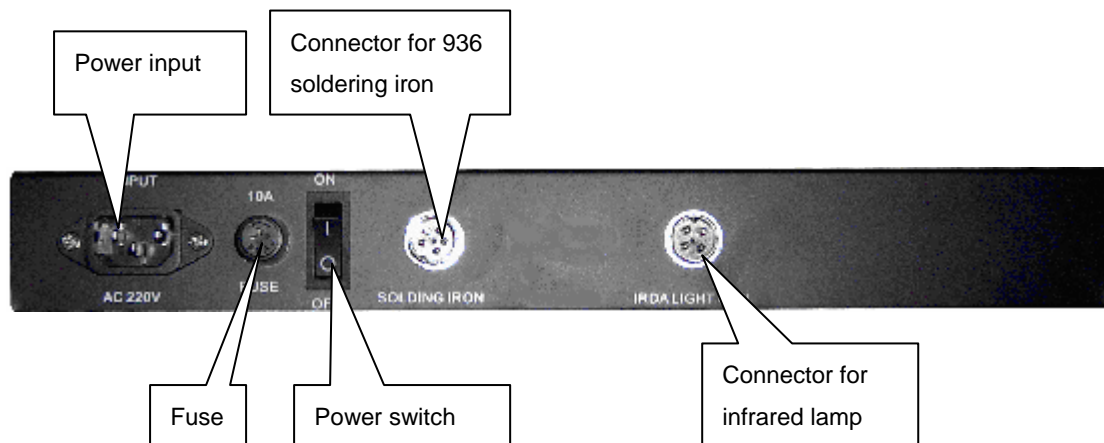

4. Focusing support

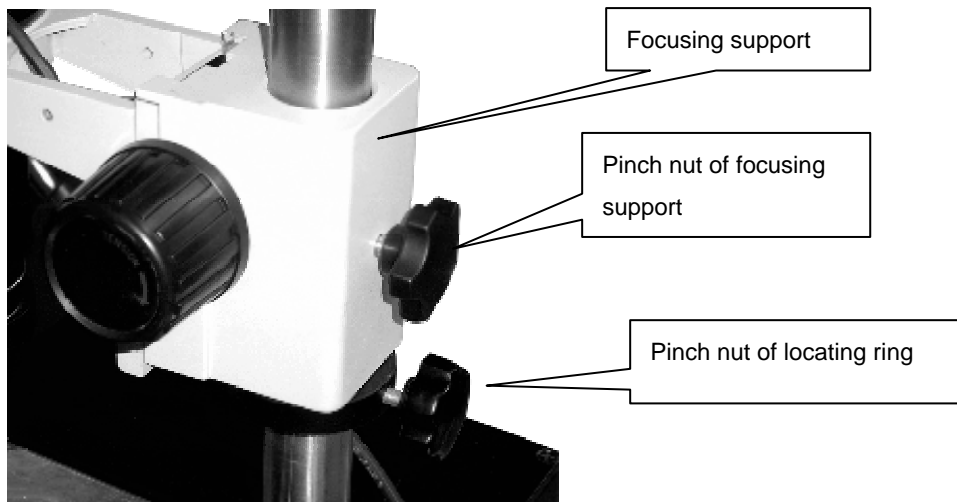
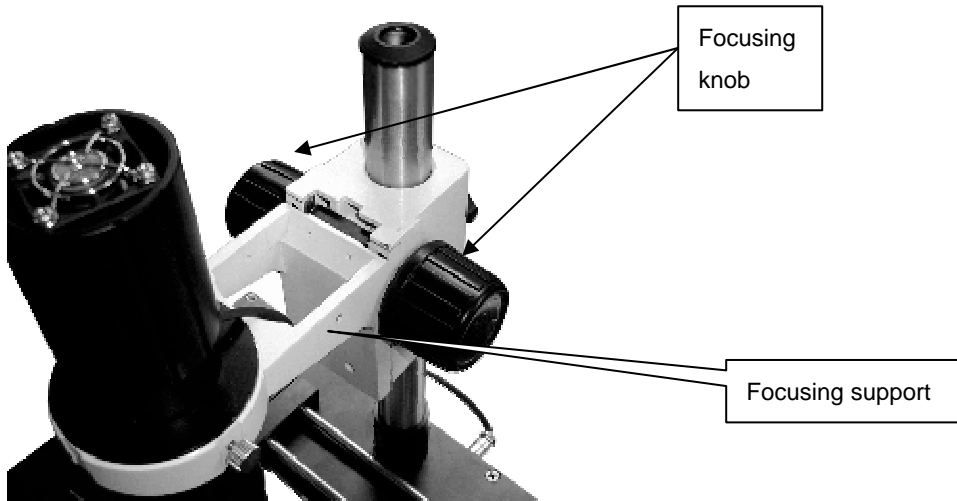

Installation

1. Install the Guide rod. Loosen the pinch nut of focusing support; put the guide rod in according to the direction of arrow icon pointing.

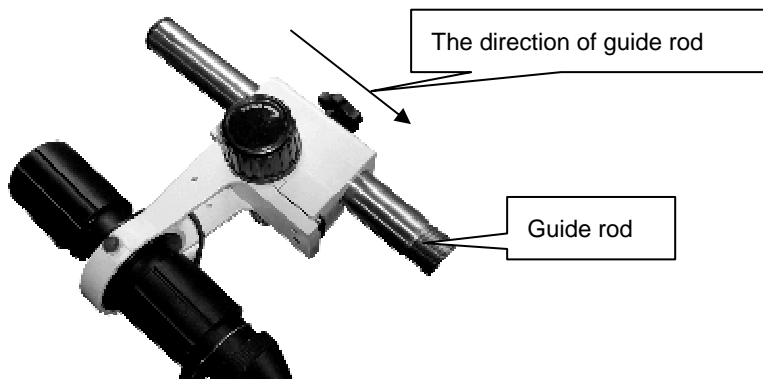

2. Put the locating ring in. Loosen the pinch nut of locating ring, put the locating ring in according to the direction of arrow icon pointing and fasten the nut to the appropriate height.

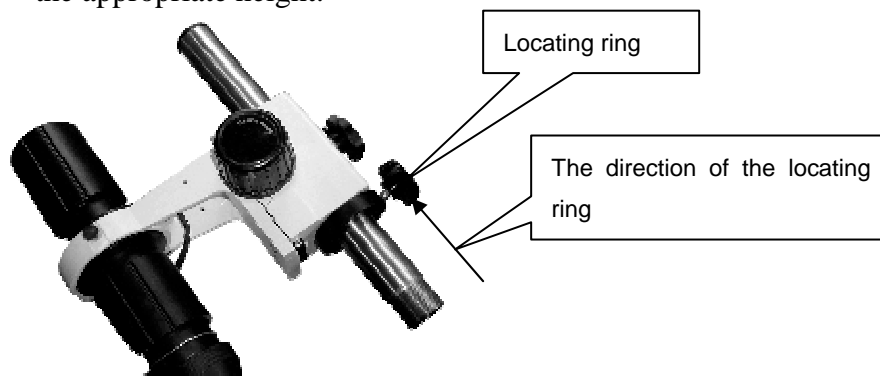

3. Machine assembled.

Loosen the pinch nut of focusing support.

Pick up focusing support, make the guide rod aim at the corresponding nut on the base, then rotate the guide rod.

Fasten the focusing support by rotating pinch nut of it.

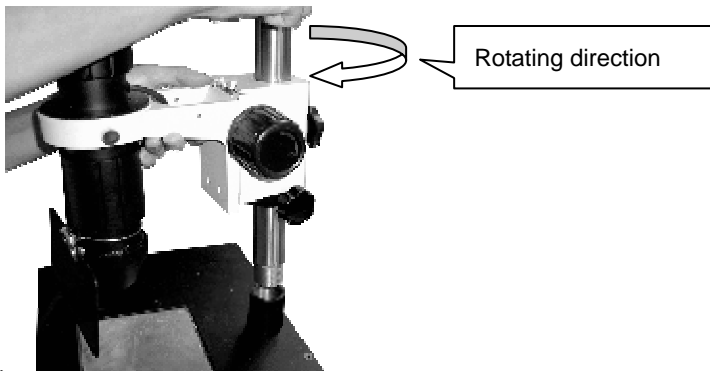

4. Connecting the wire of the lamp body.

Get the adapter of connecting wire plug in the socket of infrared lamp connecting wire.

Rotate set screw clockwise.

Operating instruction

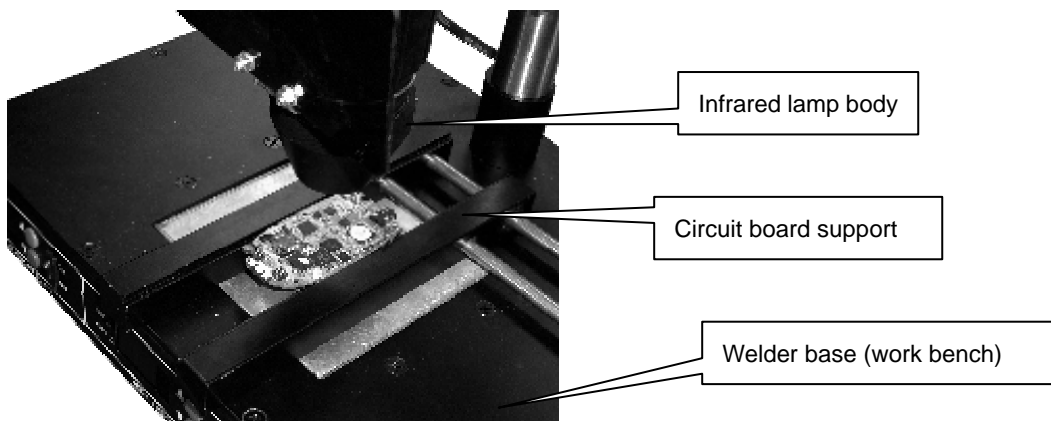

1. Starting

- ① Inspect the infrared lamp body, temperature sensor and power line and see if they are in good connection.
- ② Turn on the power switch, then use self-checking first (The previous setting value demonstrated on the keyboard display monitor after you turn on the machine).
- ③ Put PCB on the corresponding notch in PCB support, and adjust the pinch nuts of locating ring and focusing support, then adjust the height of infrared lamp body, the ideal height between lamp and the unsoldering article is 20-30mm.
- ④ Select the suitable heating temperature. Select the suitable heating temperature of infrared lamp between 60-350°C, according to the chip size that need to be unsoldered. When you unsolder chips which are about 15x15mm, you adjust the infrared lamp's temperature to 240-300 . When

unsoldering chips which are about 30x30mm, you adjust the infrared lamps temperature at 300-350 . The infrared ray lights directly, infrared ray is the strongest when the temperature is up to 350 (you need pay attention to the timing, and prevent from burning out the chip).

⑤ Adjust the focus. The minimum focal diameter of infrared lamp body is 15mm; the maximum is above 30mm, adjust them according to different chips. Usually, the ideal height between lamp and the chip is 20-30mm. Adjust the focusing knob by the size of the chip. Ideally, the bright spot should cover the whole chip.

⑥ Turn on the two switches on the front panel for the pre heating plate and the infrared lamp.

2. Unsoldering operation

Adjust temperature, make the center of the infrared lamp aim at the unsoldered chip.

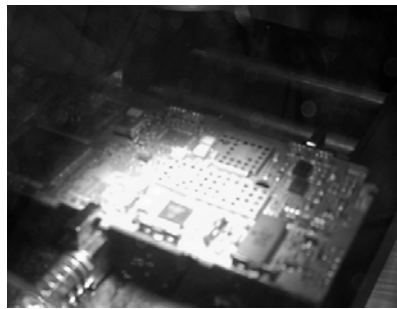

② Once the tin is sufficiently melted, remove the chip.



3. Soldering operation

Clean up the welding plate with a brush.

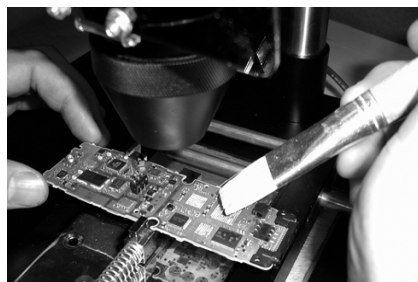

② Put the tin ball and spread soldering flux (not too thick, only a thin layer of it) on

the soldering plate.

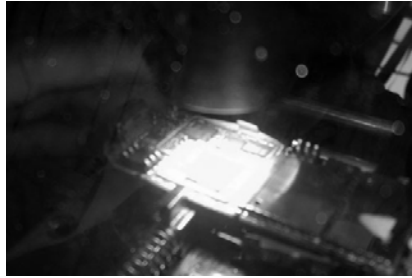

③ Put the chip in the accurate place after the solvent volatilizes out of soldering flux, heat the tin ball until it melts and solder the chip.



4. Using the lead-free soldering iron

Switch on the power, set the temperature that you need, turn on the switches.

Caution!

1. Do not cut the power off right after the work finished. You need to wait until the fan cools down the lamp body.
2. Keep the lamp body clean and the ventilation opening free of any obstructions.
3. The guide rod and the focusing support should be spread with lubricant regularly.
4. Pull out the power plug if you don't use it for a long term.
5. Be careful of operating under high temperature conditions.

Warranty statement

Reminder: These machines are very heavy, between 8 to 15 kilograms and are not designed to be shipped on airplanes, but in containers that do not move. We are not the shipping company, the airplane crew, the customs agent or the carrier in your country and therefore take no responsibility for damage caused in transit.

Corollary: When our machines leave QC, they are tested, 100% new and in perfect condition.

These machines consist of modules. Should you receive a faulty or damaged module, we will be happy to replace it. However, we will not replace the complete machine; this is not covered by our warranty.

Any of these machines are extremely sensitive to power stability. You need to use professional power source DC benches to plug in these machines. The IRDA heating could burn out or malfunction if you do not have the right power source DC bench machine. DGC is responsible to give proper guidance of the use and installation of the machine; if you don't follow these, it will void the warranty.